



15315389727

271600

---

---

1	.....	1
2	.....	3
2.1	.....	3
2.2	.....	4
2.3	.....	5
2.4	.....	6
3	.....	7
3.1	.....	7
3.2	.....	8
3.3	.....	16
3.4	.....	19
3.5	.....	25
3.6	.....	31
3.7	.....	57
4	.....	61
4.1	/ .....	61
4.2	.....	72
4.3	.....	79
5	.....	80
5.1	.....	80
5.2	.....	82
6	.....	84
6.1	.....	84
6.2	.....	87
6.3	.....	87
7	.....	91
7.1	.....	91
7.2	.....	92

---

---

---

8	.....	94
8.1	.....	94
8.2	.....	102
9	.....	117
9.1	.....	117
9.2	.....	118
9.3	.....	139
10	.....	149
11	.....	150
11.1	.....	150
11.2	.....	150
11.3	.....	154
11.4	.....	154
11.5	.....	155

- 
- 1.
  - 2.
  - 3.
  - 4.
  - 5.
  - 6.
  - 7.
  - 8.
  - 9.
  - 10.
  - 11.
  - 12.
  - 13.





---

( 2018 9 )  
2021 11 22 2021 12 02 2022 3 21 3 22

( ) 35000  
2010.68 74667m<sup>2</sup> 1#  
2#

2022 5

2022 5

---

1 (2015 1 1 )  
2 (2018 )  
3 (2018 10 26 )  
4 (2017 2018 1 1 )  
5 (2018 12 29  
)  
6 (2018 8 31 2019  
1 1 )  
7 (2020 4 29  
2020 9 1 )  
8 (2011 3 1 )  
9 (2012 7 1 )  
10 (2018 10 26 )  
11 ( [2017] 682  
2017 10 1 )  
12 ( 591 2013 )  
13 2021  
2022 2 8  
14 32 (2015.4.16)  
15 ( [2017]4 )  
16 ( ) ( 48 2018 1 10  
)  
17 < > ( [2016]186 )  
18 ( )  
2016 81 )

---

---

19

2021 70

20 < >  
( 2019 146 )

21 < >  
( [2020]4 )

22 ( [2018]5 2018 1 )

23 ( [2018]34 2018 3 )

24 ( [2021]58 2021 7 )

25 ( 2018 6 )

26 < ( ) > ( [2020]688 )

27 ( 2016 141 )

28 ( [2021]70 )

29 < > (2018 1 23 )

30 < > ( 2017 452 )

31 ( [2021]58 )

1 ( 2018 9

---

)  
2 ( 2018 11 30 )  
3 (HJ2000-2011)  
4 (HJ2015-2012)  
5 (HJ2034-2013)  
6 (HJ2035-2013)  
7 (HJ2025-2012)  
8 (GB18218-2018)  
9 (GB/T13201-91)  
10 < > (  
[2010]113 )  
11 (2019 ) ( 11 )  
12 < > (  
2017 452 )  
13 (HJ942-2018)  
14 (2021 3 1 )  
15 (DB37/T3535-2019)  
16 (HJ 819-2017)  
17 (HJ 1087-2020)  
18  
(HJ1116-2020)

1

2

3

---

1 (

370911-2022-003-M)

2 ( ZZHJA21-0243-01-01 ZZHJA21-0243-01-02

ZZHJA21-0243-02-01 ASRTHJ-2022031501)

3 ( 91370000863056413H002V)

4

5

---

---

65227.5m<sup>2</sup>

36.025N 117.071E

3.1-1

3.1-1

3.1-2

			(m)	
1		S	560	
2		SW	900	
3		NE	1500	
4		SW	1700	
5		SE	2200	
6		NNE	2400	
7		ESE	2500	
8		SW	2600	
9		SW	2700	
10		S	2800	
11		SSW	3000	
12		SSW	3000	
13		NE	3000	
14		NE	3000	
15		WSW	3200	
16		NE	3200	

2

3

1#

2# 3# 4# ( )

3.1-3

630m<sup>2</sup>

1050m<sup>2</sup>

3.1-4

1

1		/	5500	20-70%	
2	PVAC	/	3000	30-70%	
3		/	1000	30-70%	1045 /
4		/	3000	30-50%	3030 /
5		/	1500	20-60%	
6		/	2000	30-70%	
7		/	2500	40-50%	
8		/	1000	30-200	
9		/	3000	5-70%	
		/	22500	--	--
1		/	60	99.95%	
2		/	10	99.9%	

(Q/TSBXJRJ001-2019)

			(%)	(um)(Dav)			(mPa.s/25 )	
1			20-70	0.05-6			0-20000	
2	PVAC		30-70	0.1-10			0-20000	
3			30-70	0.1-10			0-20000	
4			30-50	0.1-8			0-10000	
5			20-60	0.1			0-20000	
6			30-70	0.1-10			0-20000	
7			40-50	0.1-10			0-20000	
8			5-70	--			0-3000	
			( )	(um) /%				
				355	250	150	75	
9			90-130	1.0	30	40	40	10

1	(PT)	(GB/T 1419-2015)		99.95%
2	(RH)	(GB/T 1421-2004)		99.9%

107

20

87

240

8

5760

1#

2#

---

3.2-3

1#	3	2000	1500	2500					--
			( 5500 )						
2#	3	PVAC	( 3000 )	2	2	3000			
	1000		3000	1045	2	3000			
		1000	2	(		3030			3.5
		3000	)						
	1	10							--
		60							--
(	1	3	732m <sup>2</sup>						--
)	1	4	735m <sup>2</sup>						

		1 2 396m <sup>2</sup> 5268.615KW	1 3 418m <sup>2</sup> 6800.795KW	
		1 1 262.5m <sup>2</sup>		--
1#		1 1 5764.5m <sup>2</sup>		--
2#	1	1 1460m <sup>2</sup>		--
3#		1 1 624m <sup>2</sup>		--
4#		1 1 624m <sup>2</sup>		--
	1	1 4# 96m <sup>2</sup>		--
	1	903m <sup>2</sup> 80m <sup>3</sup> 1 80m <sup>3</sup> 25% 1m 1.2m	2 80m <sup>3</sup> 4 80m <sup>3</sup> 43m 21m	--
		--	21.05m	
		45404.08t/a	30987.5m <sup>3</sup> /a	

300 1  
 6732t/a PVAC 2 1t/h 2 1t/h  
 300 1  
 6362t/a PVAC  
 H~~0~~8A

3  
 1194.12 kwh/a 1105.33 kwh/a 205.2  
 230.4 m<sup>3</sup>/a m<sup>3</sup>/a

1 1# + +  
 1 25m 0.5m (P1)  
 2 2# + +  
 1 25m 0.5m (P2)  
 3 2# 1 25m  
 0.5m (P2)  
 4 + 9.á #G 1  
 25m 0.25



	3	43m 21m 1.2m							
		1m							
		34	18	3	1836m		22	20	5.3
						2300m <sup>3</sup>			
		24	21	3	1512m				--
		34	17	3	1734m	310	20	12	5
				m <sup>3</sup> /h		1200m		310m <sup>3</sup> /h	

(1)

2021 9 2022 1 ( 5 )

3.3-1

						( 5 )	
1			99%		2370	1045	2350.2
2			50-100%		100	42.5	96
3			60-100%		400	175.5	395
4			99%		150	64.5	145
5			99%		200	90	200.6
6			99%		100	45.5	100
7			99%		50	20	45
8			99%		50	20	45
9			99%		20	9.25	20.8
10			99%		10	4.45	10
11			99%		5	2.22	5
						(5)	
1			99.98%		1300	600	1350
2			99.98%		130	60	135
3			99.98%		60	28.9	65
4			99.98%		2	0.89	2
5			99.98%		3	1.3	3
6			99.99%		1	0.55	1.2
7	( )		99.98%		4	2.25	5
8			99.8%		5	2.4	5.5
9			99.8%		3	1.4	3.2
10	N-		99.8%		3	1.4	3.2
11			99.98%		15	7.45	16.8

						(5)		
1			99.98%		500	215	516	
2			99.98%		1	0.5	1.2	
3			99.99%		1	0.5	1.2	
4			99.98%		4	1.7	4.1	
5			99.8%		3	1.3	3.1	
6			99.99%		1	0.5	1.2	
7			99.8%		1	0.5	1.2	
8			99.98%		5	2.2	5.3	
9			98%		100	43	103.2	
						(5)		
1			99.98%		800	350	840.0	
2			99.98%		290	122	292.8	
3			99.98%		120	51	122.4	
4			99.98%		8	3.4	8.2	
5			99.98%		3	1.3	3.1	
6			99.99%		2	0.9	2.2	
7			99.98%		6	2.7	6.5	
8			99.8%		7	3.0	7.2	
9			99.8%		6	2.6	6.2	
10	N-		99.8%		7	3.0	7.2	
11			98%		2	0.9	2.2	
						(5)		
1			99%		600	245	551.25	
2			99%		30	11.55	26	
3			99%		70	26	58.5	
						(5)		
1	A		99%		200	95	213.75	

2			99%		100	55	123.75
3			99%		300	130	292.5
4	1,2-		99%		100	48	108
5			99%		200	85	204
6			99%		100	50	112.5
(5)							
1			99.96%		100	38	85.5
2			99.96%		180	74.5	167.625
3			99.96%		50	20.5	46.125
4			99.8%		200	76.5	172.125
5			99.96%		180	75	168.75
6			98%		5	2	4.5
7			99.3%		7	2.9	6.525
8			99.5%		50	20	45
9			99.5%		50	20	45
10	1,4-		99.5%		50	20	45
11			99.8%		8	3.4	7.65
12			80%		20	8.5	19.125
13			99%		100	38	85.5
(5)							
1	A		99%		700	330	742.5
2			99%		100	42	100.8
3			99%		250	114	256.5
(5)							
1			40%-50%		1050	500	1125
2			40%-50%		1050	500	1125
3			25%		130	55	132

						(5)		
1					10	4	9.6	
2			31%		20.915	8.5	20.4	
3			65%		2.5	1	2.4	
4			99.6%		12.5	5	12	
5			40%		18.4125	7.5	18	
6			99.5%		53.5	22	52.8	
7			99%		65	27	64.8	
8			88%		12.5	5	12	
9			99.99%		1	0.4	0.96	

(2)

	( )	(m)	(m)	(m <sup>3</sup> / )		(mm)	(t)			
	2	4	6.5	80	0.8	DN50	119			
	1	4	6.5	80	0.8	DN50	58		1m	
	1	4	6.5	80	0.8	DN50	57		1.2m	
	1	4	6.5	80	0.8	DN50	60		43m	
25%	1	4	6.5	80	0.8	DN50	60		21m	
	1	2.5	10	21.05	0.9	DN40	17		--	

1

30987.5m<sup>3</sup>/a

---

(1)

9840m<sup>3</sup>/a(41.0m<sup>3</sup>/d)

2 1t/h

26.8m<sup>3</sup>/d 6432m<sup>3</sup>/a

310m<sup>3</sup>/h

0.145%

0.45m<sup>3</sup>/h 10.8m<sup>3</sup>/d 2592m<sup>3</sup>/a

2

3t/h

75%

78.6m<sup>3</sup>/d

25152m<sup>3</sup>/a(104.8m<sup>3</sup>/d)

10m<sup>3</sup>/a

40%

0.1m<sup>3</sup>/a

4m<sup>3</sup>/ ( 0.2m<sup>3</sup>/d)

48m<sup>3</sup>/a

29m<sup>3</sup>/

6960m<sup>3</sup>/a

5400m<sup>3</sup>/a

1560m<sup>3</sup>/a

(

) 1m<sup>3</sup>/d 240m<sup>3</sup>/a

1# 2#

2

5m<sup>3</sup>/

240m<sup>3</sup>/a

+

6

---

---

300m<sup>3</sup>/a

0.5m<sup>3</sup>/

15m<sup>3</sup>/a

555m<sup>3</sup>/a

(2)

107

6.4m<sup>3</sup>/d

1536m<sup>3</sup>/a

(3)

5243

7.86m<sup>3</sup>/d

1886.4m<sup>3</sup>/a

2

14866.9m<sup>3</sup>/a

( )

(1)

32m<sup>3</sup>/a

pH COD

BOD<sub>5</sub> SS

35.8m<sup>3</sup>/a

pH

( )

45.6m<sup>3</sup>/a( 0.19m<sup>3</sup>/d)

pH COD BOD<sub>5</sub> SS

( )

5568m<sup>3</sup>/a

pH COD BOD<sub>5</sub> SS

( )

0.8m<sup>3</sup>/d 192m<sup>3</sup>/a

pH COD BOD<sub>5</sub> SS

( )

444m<sup>3</sup>/a

---

---

pH COD BOD<sub>5</sub> SS

( )

12t/a

345.6m<sup>3</sup>/a

COD BOD<sub>5</sub> SS

( )

0.12m<sup>3</sup>/h

2.88m<sup>3</sup>/d 691.2m<sup>3</sup>/a

( )

6288m<sup>3</sup>/a

( )

(2)

5.1m<sup>3</sup>/d 1224m<sup>3</sup>/a

COD BOD<sub>5</sub>

SS

( )

3.4-1

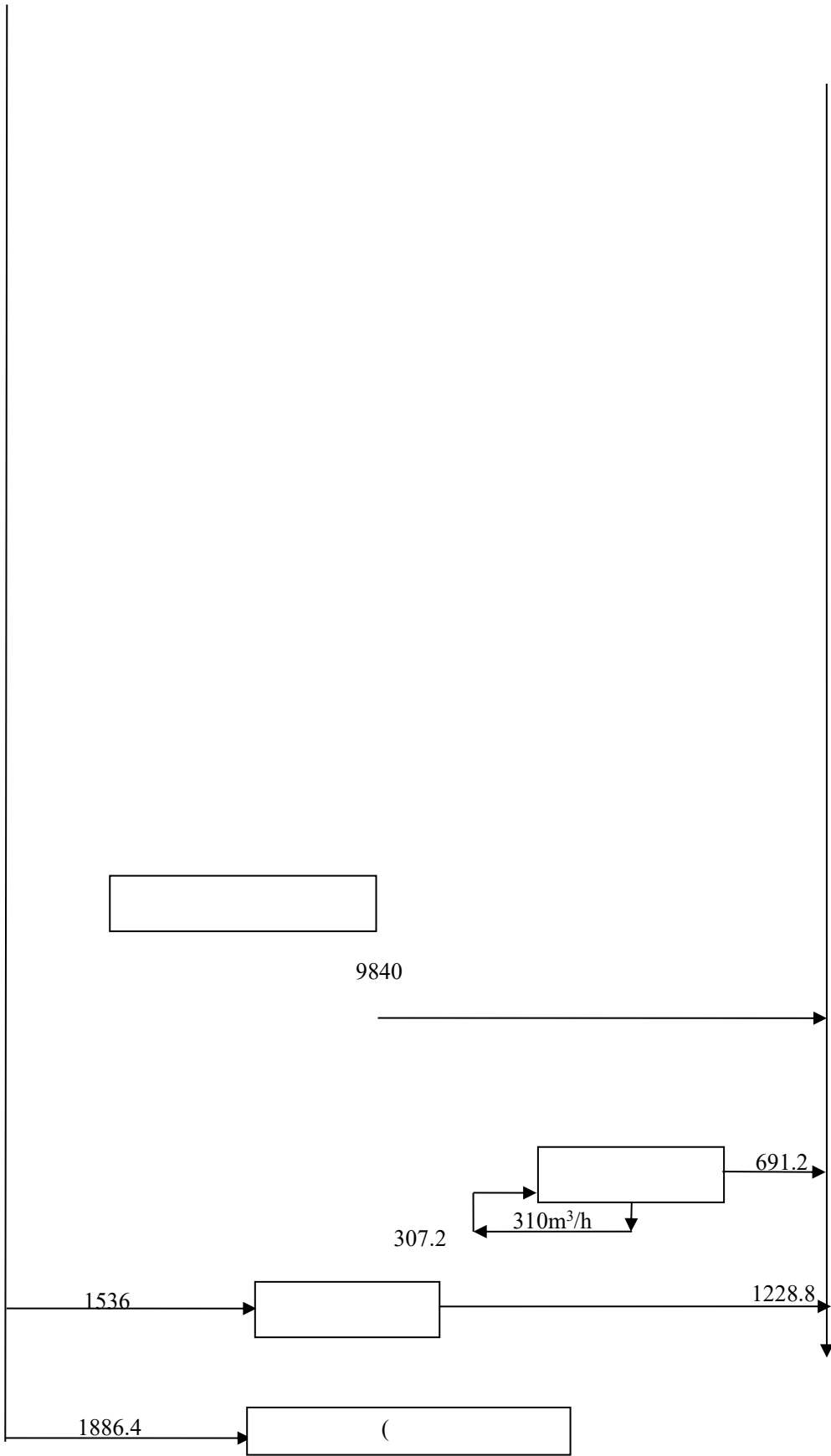

---

3.4.2

1105.33 KWh

1

R22

-20

-15

300

(t/d)

		130	--
1		100	1
		130	--
2	PVAC	85	1.5
		85	1.5
3		85	1
		85	1
4		85	



---

3

PVAC

PVAC

4

1

1 3T

3.5-1

3.5-2

			(h/ )		(h/ )		
			8-11	11	4-6	5	--
	65-90		11-15	17	8-12	13	
	65-90			3		2	
	40-90			2		1	40
	40		2-3	3	1-2	2	--
				1		1	( )
				10		8	
				8		6	HW13 265-103-13
			28.8	55	19..2	38	

---

			( )	( )	(h)	(t)	(t)	(h/a)
PVAC		5	1	200	28.8	5	1000	5760
		10	1	300	19.2	10	3000	5760

			( )	( )	(h)	(t)	(t)	(h/a)
PVAC		5	2	209	55	5	1045	5760
		10	2	303	38	10	3030	5760

3.5-1

1		6T		3		
2		1T		1		
3		2T		1		
4		12T		2		
5		6T		1		
6	( )	1T		2		
7		2T		1		
8		4T		3		
9		50T		2		3
10		2T		4		
PVAC						
1	3	3T		1		
2	1	1T		2		
3	2	2T		2		
4	300L	300L		2		
5	300L	300L		2		
10	3	3T		1		
11	5	5T		2		
12	2	2T		2		
13	3	2T		1		0
14	4	4T		1		2
15	300L	300L		1		2
16	300L	300L		1		2
17	300L	300L		1		2
18	300L	300L		1		2
PVAC						
1	5	5T		1		2
2	2	1T		1		2
3	3	2T		1		2
4	300L	300L		1		2
5	300L	300L		1		2

---

6	1	1T	1		2
1	10	10T	1		2
2	3	3T	1		2
3	7	7T	1		2
4	600L	600L	1		2
5	600L	600L	1		2
6	200L	200L	1		2
7		100L	1		2
1		3T	1		
2		2T	1		
3		4T	1		
1		6T	4		
2		4T	2		
3		12T	1		
4		3T	3		
			2		
5		--	(	--	1
			)		
1		3T	2		
2		4T	1		
3		3T	2		3
4		0.5T	2		
5		1T	4		
1		4T	3		
2		2T	1		
3		0.5T	2		
4		0.5T	2		
			2		
5		--	(	--	1
			)		

---

3		6T ( )		1		
1		1.95		1		
2		500L		4		
3	PVC			2		
1		500L		2		
2	PVC			1		
1		50KW		2		
		40KW		1		

5500 / PVAC 3000  
 / 1045 / 3030 / 1500 /  
 2000 / 2500 / 1000 /  
 3000 / 0.06 /  
 0.01 /

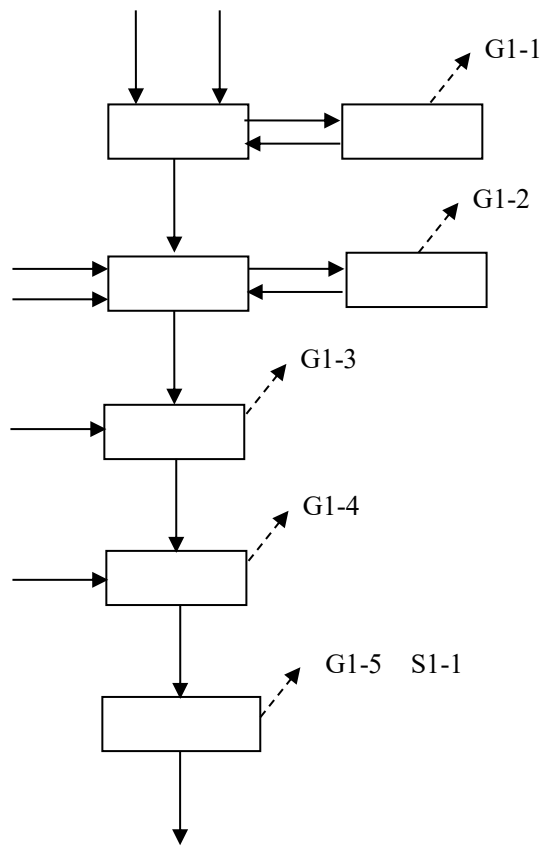

						/
	G1-1					+ 25m + (P1)
	G1-2					
	G1-3					
	G1-4					
	G1-5					
	S1-1			HW13 265-103-13		

---

--	--	--	--	--	--	--

	$n \begin{array}{c} \text{CH}=\text{CH}_2 \\   \\ \text{OOCCH}_3 \end{array} \longrightarrow - \left( \begin{array}{c} \text{CH}-\text{CH}_2 \\   \\ \text{OOCCH}_3 \end{array} \right)_n -$	
	$\text{CH}_2=\text{CHOOCCH}_3$	$[\text{CH}_3\text{COOCH}_2\text{CH}]_n$
	86.09	2 -10
	( )	
	( ) ( )	
	N-	

PVAC

(1)

(2)

65 ( )

65 90

10 15

(3)

40

PVAC

3.6-2

3.6-2-2

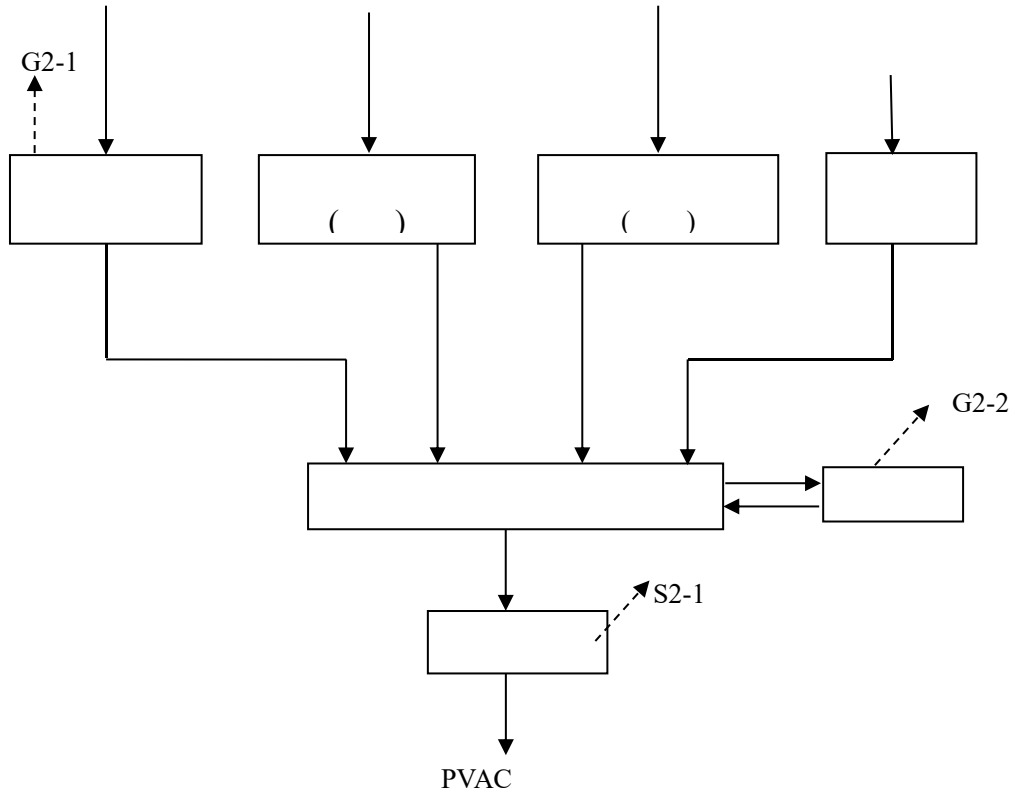

						/
	G2-1	( )				+ +
	G2-2					25m (P2)
	S2-1			HW13 265-103-13	N-	

	$n \begin{array}{c} \text{CH}=\text{CH}_2 \\   \\ \text{I} \\ \text{OOCCH}_3 \end{array} \longrightarrow - \left( \begin{array}{c} \text{CH}-\text{CH}_2 \\   \\ \text{I} \\ \text{OOCCH}_3 \end{array} \right)_n -$	
	$\text{CH}_2=\text{CHOOCCH}_3$	$[\text{CH}_3\text{COOCH}_2\text{CH}]_n$
	86.09	2 -10
	( )	( )
	( )	( )

(1)

( )

\$' 8 ° Ñ•À

(2)

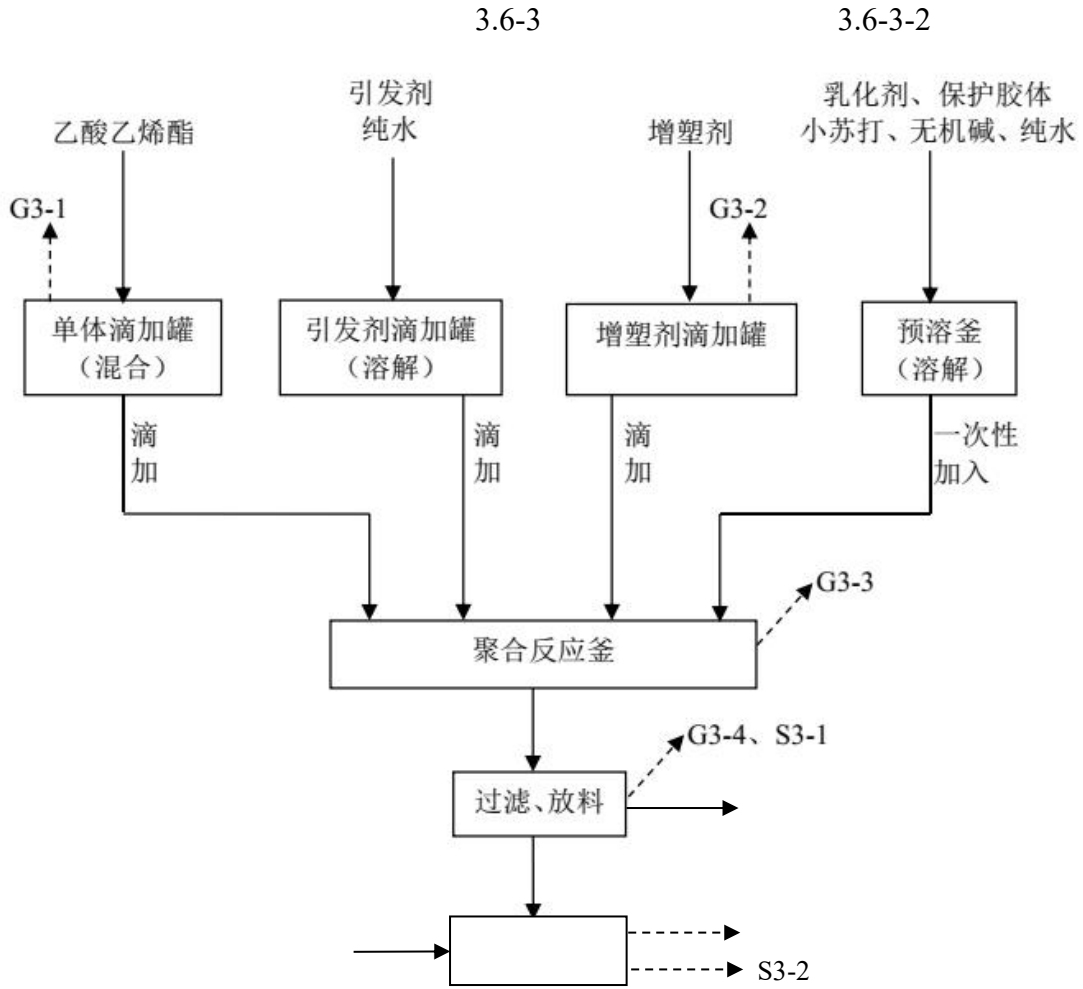

						/
	G3-1					+ + (P2) 25m
	G3-2				( )	
	G3-3				( )	
	G3-4				( )	
	S3-1					
	S3-2			HW13 265-103-13		



(4)

( )

10

3.6-4

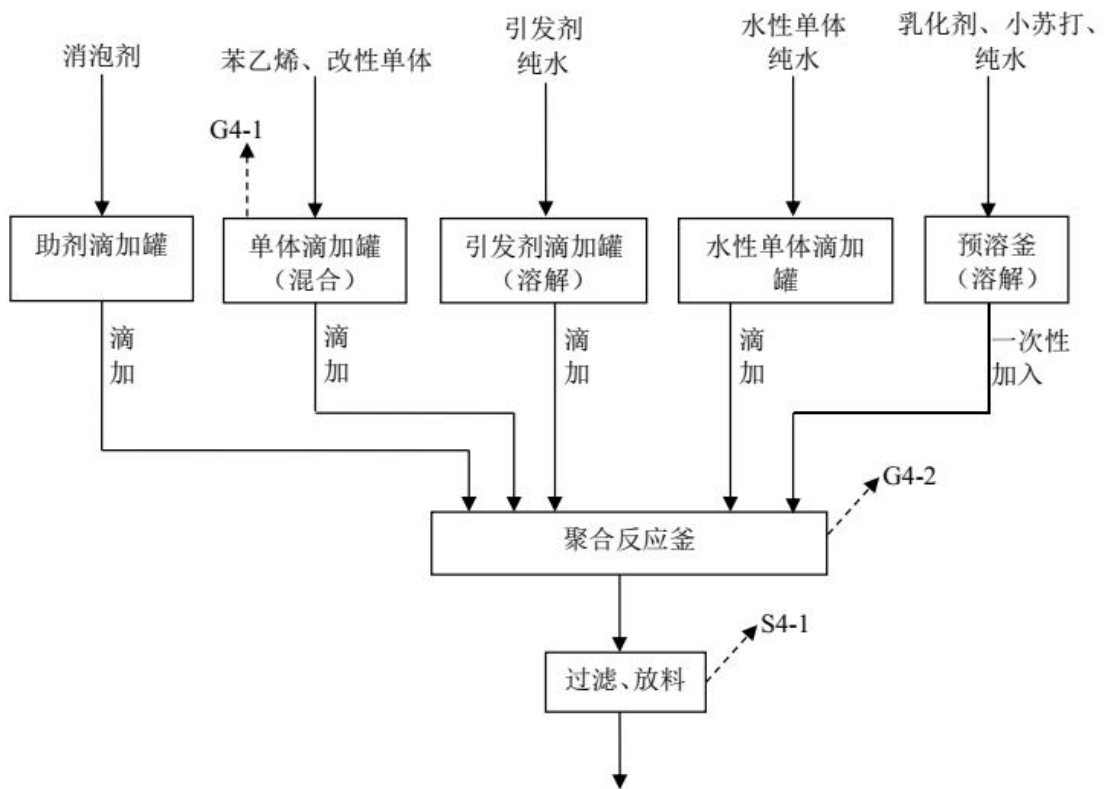

G4-1

+ +

G4-2

25m  
(P2)

S4-1

---

---

	S4-2		HW13 265-103-13	N-	
--	------	--	--------------------	----	--

(160 )

(160 )

(1)

---

---

						/
	S5-1			HW13 265-103-13		

(2)

50

50

(3)

3.6-6

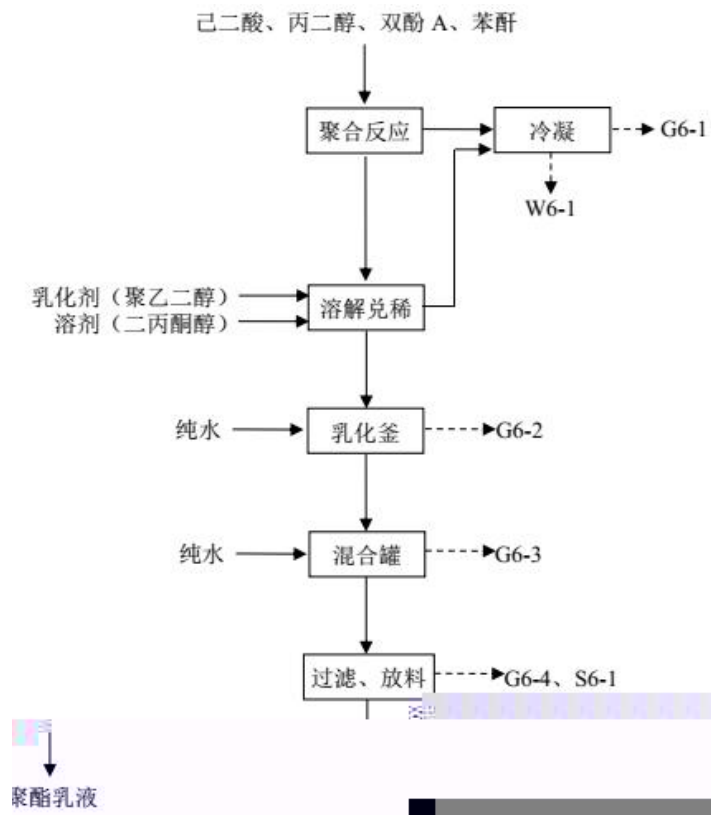

						/
	G6-1				1,2-	+ 25m (P1) +
	G6-2					
	G6-3					
	G6-4					
	W6-1			--	1,2-	

	S6-1			HW13 265-103-13		

70-110

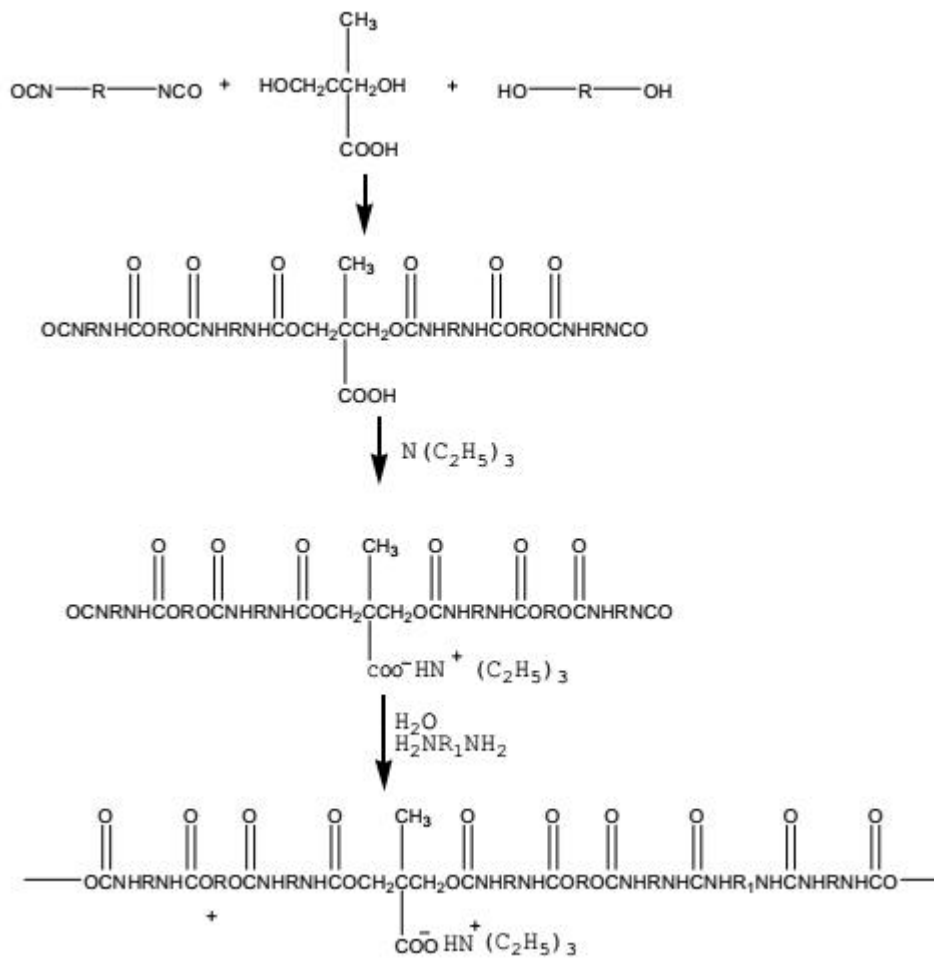

(1)

---

70-110 ( )

(2)

60-70

0.5-1h

+

( )

90%

(3)

50-60

0.5

(4)

50-60

40-50

DCS

30

(5)

1h

3.6-7

3.6-7

						/
	G7-1					+ + 25m (P1)
	G7-2					
	G7-3					
	G7-4					
	G7-5					
	G7-6					

S7-1			HW13 265-103-13		
------	--	--	--------------------	--	--

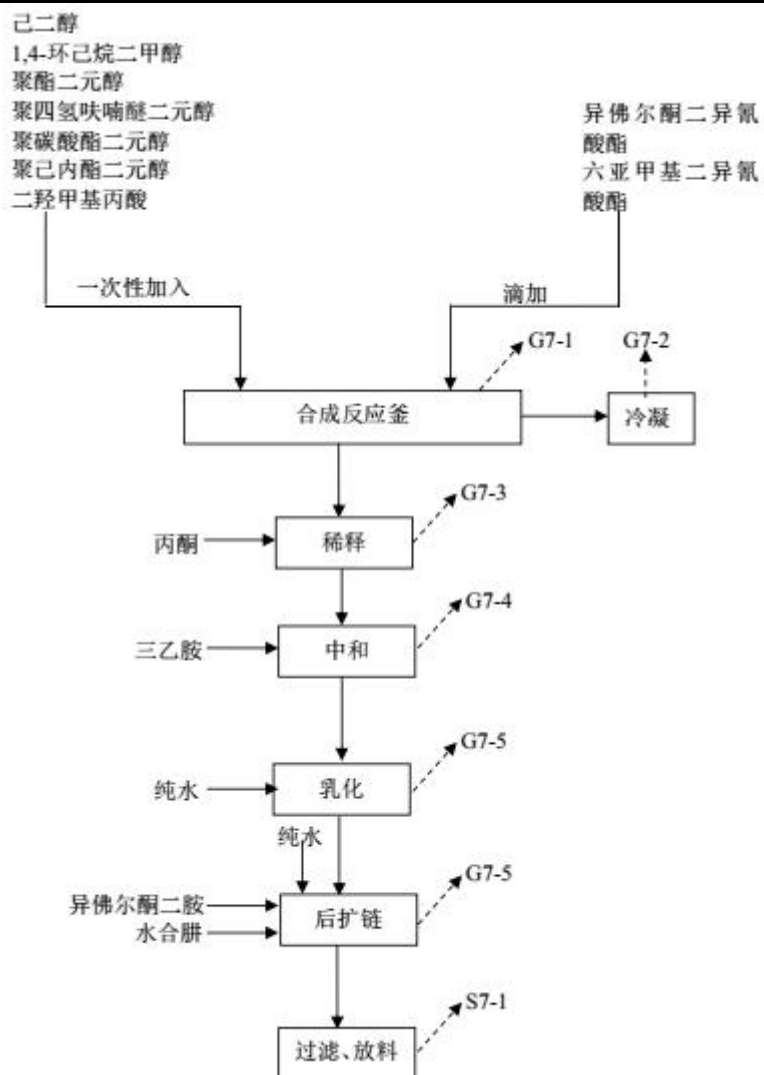

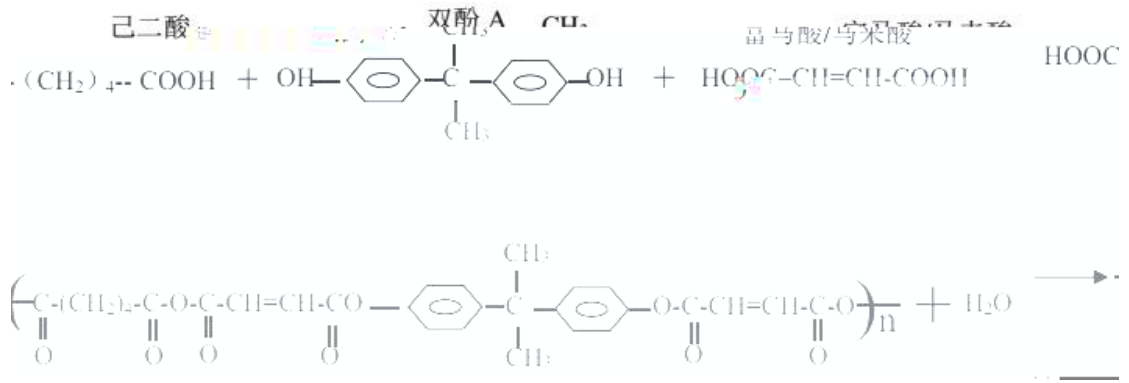

(1)

200

(-0.1MPa)

(2)

(200 )

(3)

3.6-8

双酚 A 及其衍生物、己二酸、富马酸

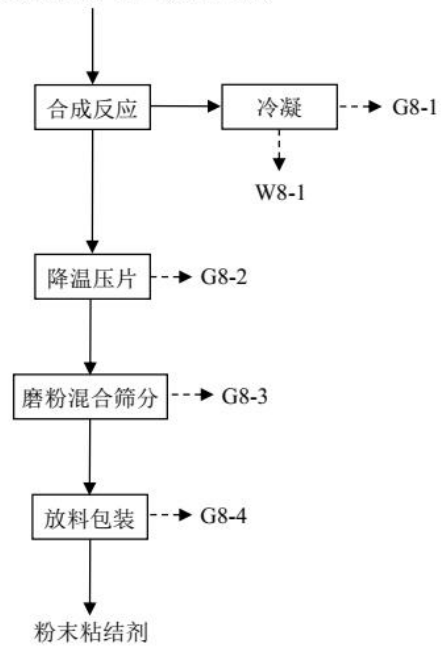

						/
	G8-1					+ + 25m (P2)
	G8-2					+ + + 25m (P2)
	G8-3					25m (P6)
	G8-4					25m (P6)
	W8-1			--		

A

( )

(1)

(2)

30min

(3)

A

3.6-9-1

环氧类乳液、聚乙酸乙烯类乳液

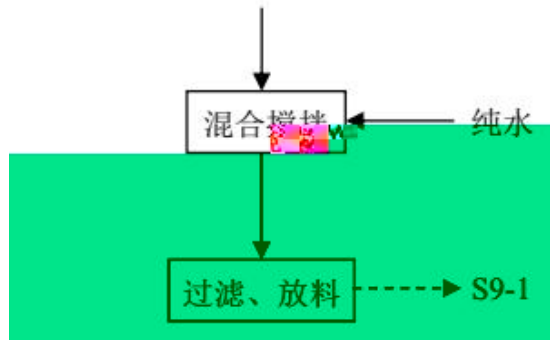

						/
	S9-1			HW13 265-103-13		

pH

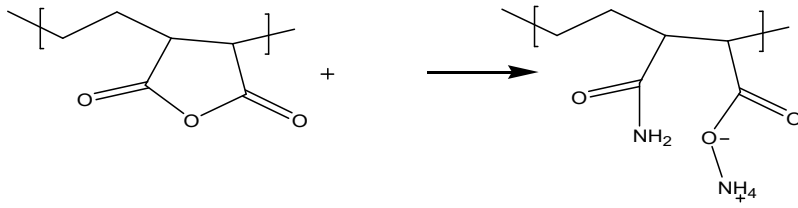

pH

1

85

(2)

(3)

85                      4h                      40

4                                      pH

25%                      pH      8-10

(5)

30min

B

2.2-6-9-2

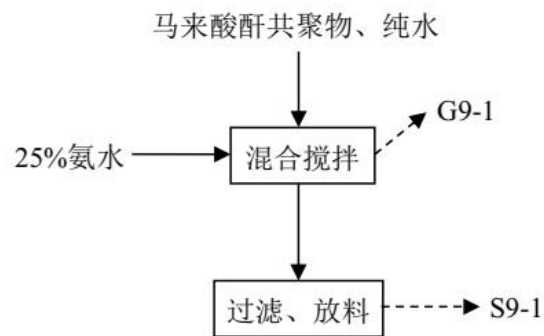

						/
	G9-1					+      +
					25m	(P2)

	S9-1			HW13 265-103-13		
--	------	--	--	--------------------	--	--

99.95%

99.9%

1

(1)

4:1

100

3 4

(  
)

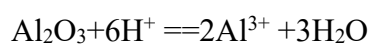
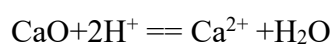

(2)

5 6

2 Pt

4 Pt

pH 7

3 4

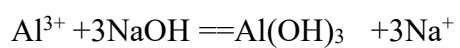
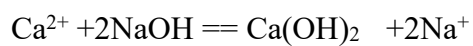
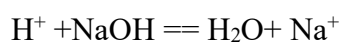
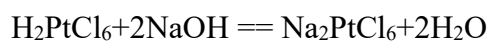
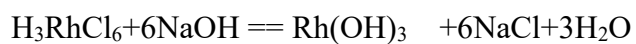
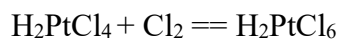

(3)

30

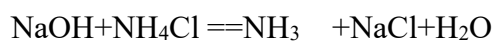
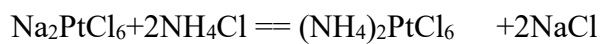

(4)

900

99.95%

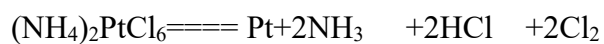

50

10

5

3.6-10-1

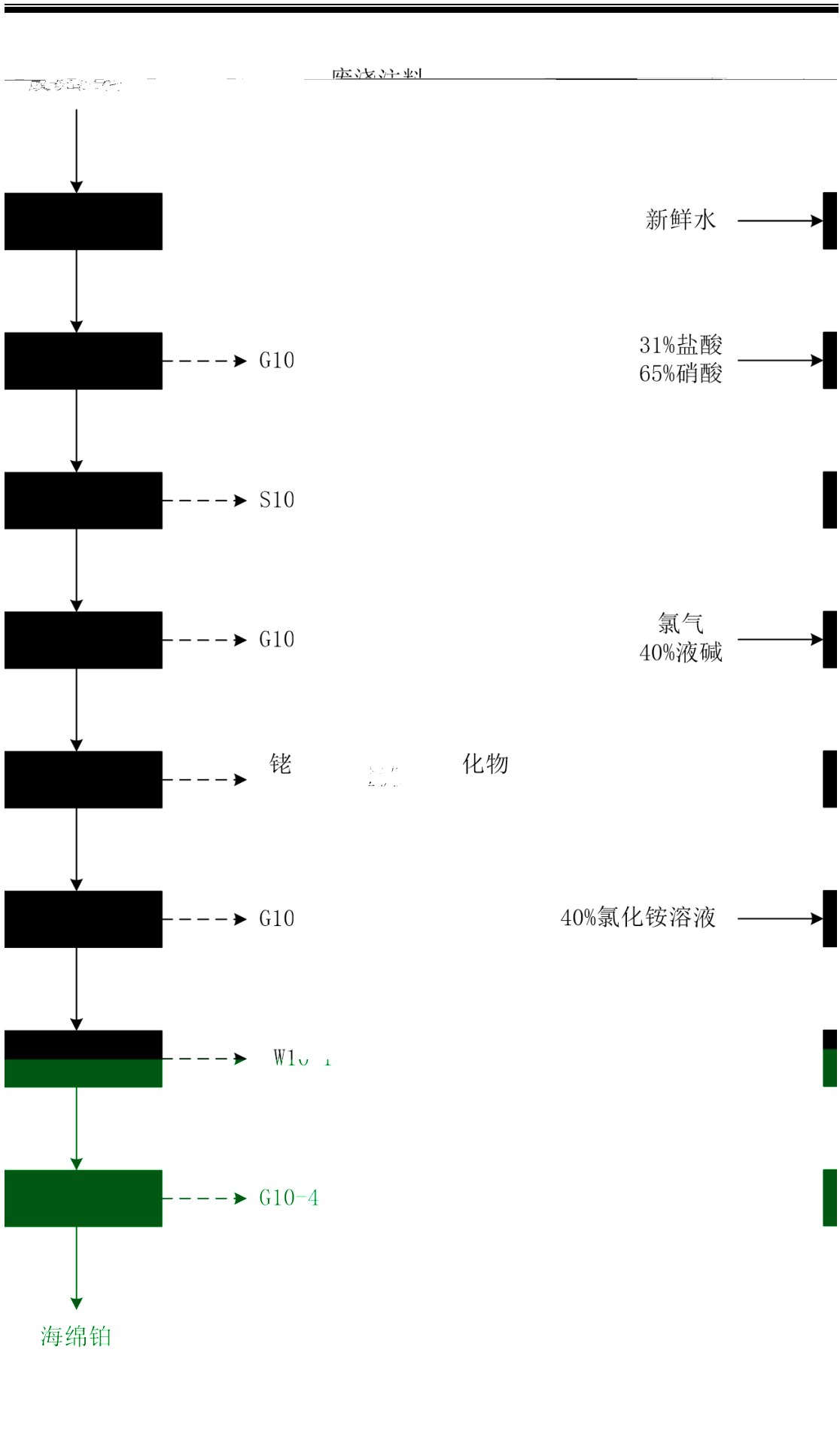

						/
	G10-1				NO Cl <sub>2</sub> HCl ( NO <sub>x</sub> )	+ 25m (P3)
	G10-2				Cl <sub>2</sub>	
	G10-3					
	G10-4				NH <sub>3</sub> Cl <sub>2</sub> HCl	
	W10-1				NaCl NaNO <sub>3</sub>	
	S10-1				( )	

2

(1)

80

1 2

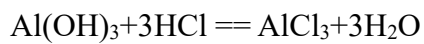
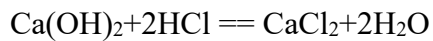
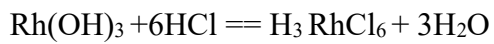

(2)

pH

2

80

(NaNO<sub>2</sub>)

Na<sub>3</sub>Rh(NO<sub>2</sub>)<sub>6</sub>

1 2

pH

7

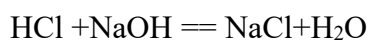
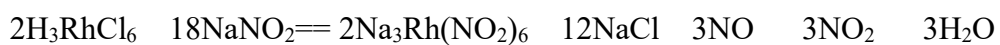



---

800

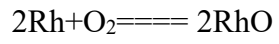

7

800

30

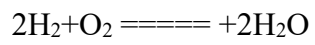
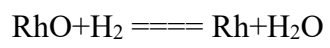

3.6-10-2

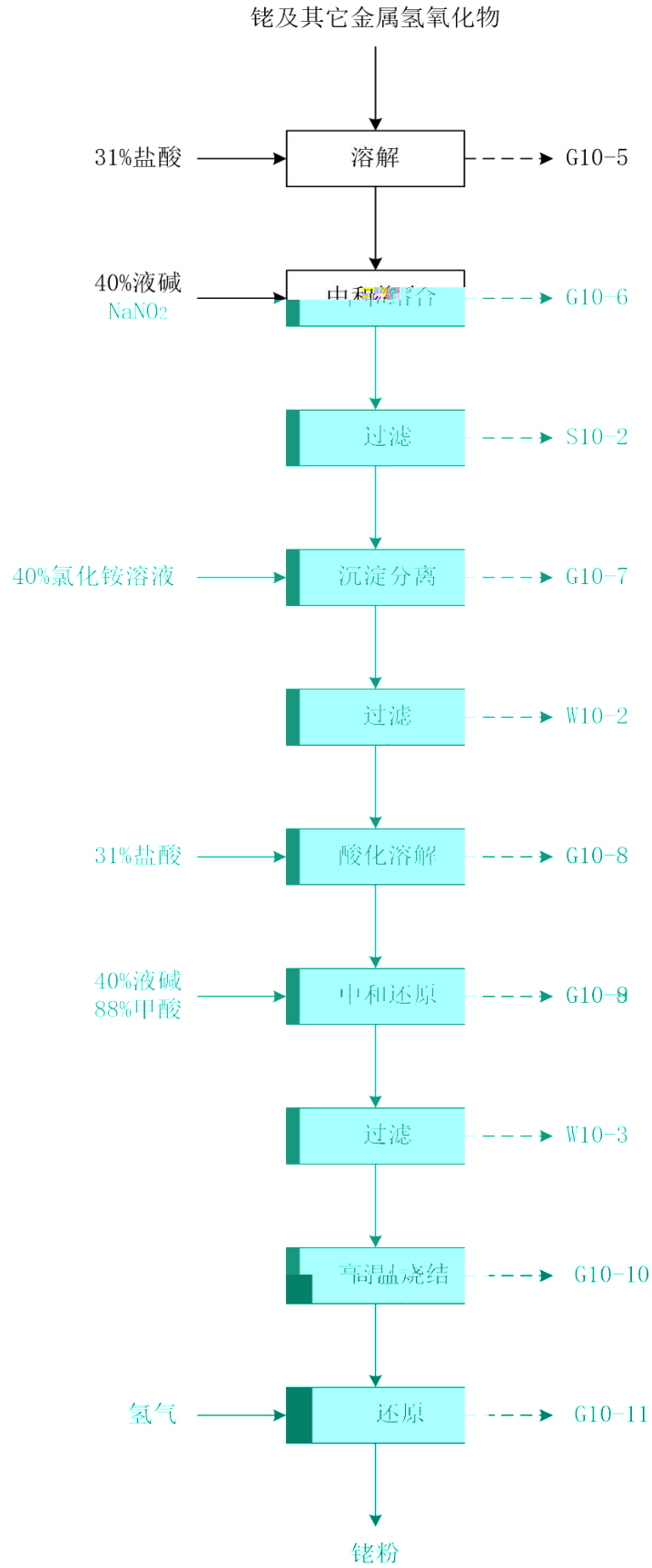

						/
	G10-5				HCl	25m + (P3)
	G10-6				NO NO <sub>2</sub>	
	G10-7					
	G10-8				NO NO <sub>2</sub> HCl	
	G10-9				CO <sub>2</sub>	
	G10-10					
	G10-11					--
	W10-2				NaCl NaNO <sub>3</sub>	
	W10-3				NaCl	
	S10-2			--		

	3.5-1	1 PVAC	3.5

			1	
	2# + + 1 0.5m 25m P2 2# 1 25m (P2) 0.5m + 1 0.25m 25m (P3) + 1 0.3m 25m (P4)	2# + + 25m 0.8m (P2) 2# 25m 0.6m 1 (P6) + 1 27m (P3) 0.33m + + 1 25m (P4) 0.5m	1	< > ( 2019 146 ) < ( [2020]4 ) VOCs 1 + P4

( ) (

2020 688 )

	2020 688		
1.			
2.	30%		
3.			
4.	(		
)	10%		
5.	(		
)			
6.	(		
)			

(1) )	(		
(2)			
(3)			
(4)	10%		
7.	10%		
8.	( 10% )	6	1 + + +
9.			
10.	( )		
10%			
11.			
12.	( )		
13.			

2016 141 )

(

2016 141

- 1.
- 2.



< ( )> ( )  
[2020]688 )  
( 2016 141 )



---

4.1.1.1

)

1 1#

1#

+ +

1 25m 0.8m (P1)

2 2#

2#

PVAC

+ +

1 25m 0.8m (P2)

---

3 2#

2#

1 25m 0.6m (P6)

4

NH<sub>3</sub> NO NO<sub>2</sub> Cl<sub>2</sub> HCl  
+ + 1 27m  
0.33m (P3)

5

+  
+ 1 25m 0.5m  
(P4)

6

1 300 1  
25m 0.6m (P5)

4.1-1

4.1-2

	G6-4 G7-6 G7-6 G7-6		+ P1	
2# ( PVAC )	G2-1 G2-2 G2-1 G2-2 G3-1 G3-2 G3-3 G4-1 G4-2 G8-1 G9-1	VOCs(  )	+ + P2	
	G3-4 G8-2		+ + P2	
	G8-3		P2	P6
	G8-4		P2	P6
	G10-1 G10-2 G10-3 G10-4 G10-5 G10-6 G10-7 G10-8 G10-9	NO ( NO NO <sub>2</sub> ) Cl <sub>2</sub> HCl NH <sub>3</sub>	+ P3	+ P3
	G11	VOCs	+ P4	+ P4

2

	GI	P5
--	----	----

4.1.1.2

(1)

(2)

a

( )



+

+

(GB 37822-2019) (1)

VOCs

(2)

( )

(3) VOCs

VOCs

(4)

VOCs

VOCs

VOCs

VOCs

(5)

VOCs

(6)

VOCs

VOCs

VOCs

3 (7)

1

14866.9m<sup>3</sup>/a

(1)

32m<sup>3</sup>/a

pH COD

BOD<sub>5</sub> SS

35.8m<sup>3</sup>/a

pH

( )



---

---

45.6m<sup>3</sup>/a( 0.19m<sup>3</sup>/d)

pH COD BOD<sub>5</sub> SS

( )

5568m<sup>3</sup>/a

pH COD BOD<sub>5</sub> SS

( )

0.8m<sup>3</sup>/d 192m<sup>3</sup>/a

pH COD BOD<sub>5</sub> SS

( )

444m<sup>3</sup>/a

pH COD BOD<sub>5</sub> SS

( )

12t/a

345.6m<sup>3</sup>/a

COD BOD<sub>5</sub> SS

( )

0.12m<sup>3</sup>/h

2.88m<sup>3</sup>/d 691.2m<sup>3</sup>/a

( )

6288m<sup>3</sup>/a

( )

(2)

5.1m<sup>3</sup>/d 1228.8m<sup>3</sup>/a

COD BOD<sub>5</sub>

SS

( )

2

---

250L/d

100m<sup>3</sup>/d(            +    +            +  
62.0m<sup>3</sup>/d            200m<sup>3</sup>/d            )

(    )

4.1-3

4.1-4

4.1-5

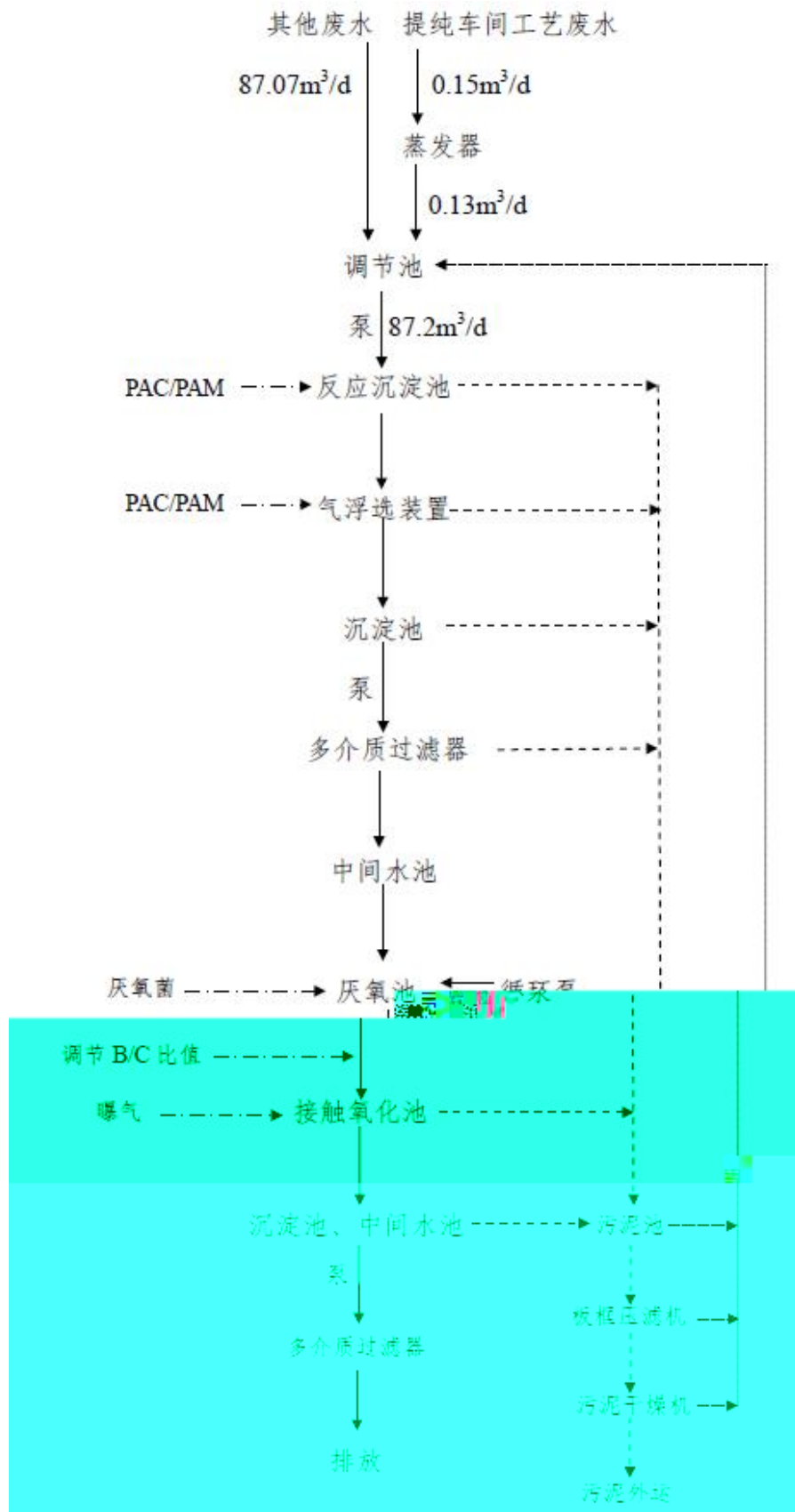

---

1

				(5 )		
			0.25t/3a	--	0.25t/3a	
			99t/a	40 t	96t/a	
			1.314t/a	0.61 t	1.464t/a	
			27t/a	5.6 t	13.44t/a	

								(5 )				
1				HW13	265-103-13		4.2t/a	1.8 t	4.32t/a			T
2				HW13	265-101-13		2.25t/a	0.9 t	2.16t/a			T
3				HW34	261-057-34	( )	10.57t/a	4.2 t	10.08t/a			C T
4				HW08	900-249-08		9t/8a	--	9t/8a*			T I
5				HW49	900-039-49		11.4t/a	6 t	12t/a			T
6				HW06	900-402-06		13t/a	5 t	12t/a	2-3		T I R
7	( 30%)			HW13	265-104-13		235.88t/a	92.5 t	222 t/a			T
8				HW49	900-041-49		1t/a	0.45 t	1.08t/a			T In
9				--	--		3.24t/a	1.3 t	3.12t/a			--

---

10				HW11	900-013-11		11.8t/a	5 t	12t/a		--	
*												

2

1

334m<sup>2</sup>

4.1-6

---

1

43m 21m 1.2m

150mm

2

(1)

--5KG/m

--200 C30(P6)

--1.5

--100 C15

0.94

20

1.5mm

--20 1: :2

--120 C20

--0.2

0.9

(2)

100mm C20

P6

1: 2

20mm

(3)1# 2# 3# 4# 1# 2#

--5KG/m

--200 C30(P6)

--1.5

--100

C15

0.94

(4)

1# 2#

(300\*300)--1:3

(

)--

( 1.5 ) -- --20 1:3  
 --100 C15 -- 0.94

(5)

--5KG/m

( )--200 C30(P6) --1.5  
 --100 C15 0.94

4.2-1

3

		( )
1		1
2	DCS	7
3		5
		23
5	1#	15
6	2#	14
7		5
8		5
9	3#	18
10	4#	12

4

			20	1 2	1
			15	1 2	1
			20	1 2	1
			14	1 2	1 3 4
			14	1 2	1
			1		1
			6		1
			5		1
			5		1
2		MF/ABC8	116		
		MF/ABC4	60		

		MF/ABC35	16	
		5	40	DCS
			100	
			28	
			197	
			225	
			102	
			112	
			90	
			53	DCS
			13	
		PY4/200	3	3
			130	1
			20	
			20	
			8	
			1	1
			8	
			14	
			2	
			2	
			4	
			2	
			4	

5 ( )

( ) 3

1 ( J1) 1#

1 ( J2#) 1 (

J3#)

(GB/T14848-2017)

1.01 3.74



		1512m <sup>3</sup>	
	3 1 )	( 1 1 )	3 1 )

( BA2022370903028284)

CODcr

(CODma II)

(Amta NA8000)

1# 2#

1

VOCs

(

BA2022370903015540 BA2022370903015914)

HV-3060

1

2

(HJ

819-2017)

(HJ 1087-2020)

			VOCs( )	
	1#	VOCs( )		
	2#	VOCs( )	VOCs( )	
	3#	( NO )		
		Cl <sub>2</sub> HCl NH <sub>3</sub>		
	4#	VOCs( )		
	5#	SO <sub>2</sub> NO		
	6#			
		VOCs( ) HCl HNO <sub>3</sub> ( NO )		
		pH	pH COD	

		pH		
	1m( )	Leq(A)		

		TSP HCl NO VOCs		
		pH COD BOD <sub>5</sub>		
		pH		
		( ) 1,1- 1,2- 1,1- -1,2- -1,2- 1,2- 1,1,1,2- 1,1,2,2- 1,1,1- 1,1,2- 1,2,3- 1,2- 1,4- + 2- [a] [a] [b] [k] [a,h] [1,2,3-cd]		







---

--	--

1

2

3

4

( )

[2019]210

---

1

2

3

( )

5

4

5

10

2019 10 28



6

(DB37/2801.6-2018) 1 2 (GB  
 31572-2015) 4 GB  
 37824-2019 1 (DB37/2376-2019) 1  
 (GB16297-1996) 2  
 (GB31573-2015) 3  
 (DB37/2374-2018) 2 ( )  
 (DB37/3161-2018) 1  
 6  
 (DB37/2801.6-2018) 3 (GB31573-2015)  
 5 ( )  
 (DB37/3161-2018) 2 (GB14554-1993) 1  
 (GB16297-1996) 2  
 (GB 37822-2019)

			(mg/m <sup>3</sup> )	kg/h	
1#		(DB37/2801.6-2018) (GB 31572-2015) 4 GB 37824-2019 1	6	10	0.3
			20	0.3	
	VOCs( )		50	3.0	
			50	--	
			60	--	
2#		6	20	--	



	VOCs( )	(DB37/2801.6-2018)	50	30
		(GB 31572-2015) 4	60	--
		GB 37824-2019 1		
		(GB14554-93)	--	14
2#		(DB37/2376-2019) 1		
		(GB 31572-2015) 4	10	14.5
		GB 37824-2019 1		
		(GB16297-1996) 2		
	NO	(DB37/2376-2019) 1	100	2.85
	Cl <sub>2</sub>		5	0.52
	HCl		10	0.92
	NH <sub>3</sub>	(GB31573-2015) 3	20	--
	VOCs( )		100	5.0
		( )	10	1.6
		(DB37/3161-2018) 1	20	1.0
			3	0.1
			800( )	--
			10	--
	SO <sub>2</sub>		50	--
	NO	(DB37/2374-2018) 2	100	--
			1	--
			1.0	--
	Cl <sub>2</sub>	(GB16297-1996) 2	0.1	--
	HCl		0.05	--
	NO	(GB31573-2015) 5	0.12	--
	VOCs( )	(DB37/2801.6-2018) 3	2.0	--
		( )		
		(DB37/3161-2018) 2		

		6	0.2	--
		(DB37/2801.6-2018) 3	0.2	--
		( )	1.0	--
		(DB37/3161-2018) 2	1.0	--
		(GB14554-1993) 1	0.03	--
		( )	20	--
		(DB37/3161-2018) 2		
	VOCs( )	(GB 37822-2019)	10	--

(GB/T31962-2015)

1 A ( )  
(GB31573-2015)

(GB/T31962-2015) 1 A	pH	6.5 9.5
	COD	500 mg/L
	BOD <sub>5</sub>	350 mg/L
	SS	400 mg/L
		45 mg/L
		70 mg/L
		8 mg/L
		1 mg/L
		500 mg/L
		2.5 mg/L
		64
	( )	pH
	COD	350 mg/L
	NH <sub>3</sub> -N	40 mg/L
	BOD <sub>5</sub>	250 mg/L
	SS	200 mg/L
		50 mg/L
		7.7 mg/L
	pH	6-9 mg/L

	(GB31573-2015)	SS	100 mg/L
		CODcr	200 mg/L
			40 mg/L
			60 mg/L
			2 mg/L
	3416.1-2018	1 DB 37	1600 mg/L

(GB12348-2008)3

GB12348-2008	3	65	55

(GB18599-2020)

(GB18597-2001)

0.92t/a

2.63t/a

0.386t/a

1.536t/a

6.3.1

(GB/T14848-2017)

	(GB/T14848-2017)	pH	6.5 8.5( )
			0.50mg/L
		( N )	20.0mg/L
		( N )	1.00mg/L
		( )	0.002mg/L
			450mg/L
			1000mg/L

		3.0mg/L
		1.0 mg/L
		250mg/L
		250mg/L
		0.05mg/L
		3.0 CFU/100mL
		200mg/L
		0.01mg/L
		0.001mg/L
	( )	0.05mg/L
		0.01mg/L
		0.005mg/L
		0.3mg/L
		0.1mg/L
		1.0mg/L
		20 g/L
		0.02mg/L
		700 g/L
		500 g/L
		100CFU/100mL

6.3.2

( ) (GB36600-2018) 1

( ) (GB15618-2018)

		60mg/kg
		65mg/kg
	( )	5.7mg/kg
		18000mg/kg
		800mg/kg
( ) (GB36600-2018)		38mg/kg
		900mg/kg
		2.8mg/kg
		0.9mg/kg
		37mg/kg
	1,1-	9mg/kg

	1,2-					5mg/kg	
	1,1-					66mg/kg	
	-1,2-					596mg/kg	
	-1,2-					54mg/kg	
						616mg/kg	
	1,2-					5mg/kg	
	1,1,1,2-					10mg/kg	
	1,1,2,2-					6.8mg/kg	
						53mg/kg	
	1,1,1-					840mg/kg	
	1,1,2-					2.8mg/kg	
						2.8mg/kg	
	1,2,3-					0.5mg/kg	
						0.43mg/kg	
						4mg/kg	
						270mg/kg	
	1,2-					560mg/kg	
	1,4-					20mg/kg	
						28mg/kg	
						1290mg/kg	
						1200mg/kg	
	+					570mg/kg	
						640mg/kg	
						76mg/kg	
						260mg/kg	
	2-					2256mg/kg	
	[a]					15mg/kg	
	[a]					1.5mg/kg	
	[b]					15mg/kg	
	[k]					151mg/kg	
						1293mg/kg	
	[a,h]					1.5mg/kg	
	[1,2,3-cd]					15mg/kg	
						70mg/kg	
						1 10 <sup>-5</sup> mg/kg	
						4500mg/kg	
(	pH	pH 5.5	5.5	pH 6.5	6.5	pH 7.5	pH 7.5
		150		150		200	250
		200		200		250	300



---

7.1-1

1			pH COD BOD <sub>5</sub> SS	4

7.1.2.1

1 1#

7.1.2.2

1#	( )	1m	2		1h
2#	1.5m				
		10m	4	Cl <sub>2</sub> HCl NO VOCs( )( )	
			1		
			3		

1	1m	1	Leq(A)	
---	----	---	--------	--

		pH	( N )	(	
		N )	( )		
	2	( )			2
	1		+	47	
	(0 0.5m	pH		6	
	0.5 1.5m 1.5 3m				
	)				
	2		+	47	
	( )	pH		6	
	(0 0.5m 0.5 1.5m				

---

1.5 3m )

3

		HJ 836-2017		1.0mg/m <sup>3</sup>
	VOCs( )	HJ 38-2017		0.07mg/m <sup>3</sup>
		HJ 734-2014		0.004mg/m <sup>3</sup>
				0.004mg/m <sup>3</sup>
				0.006mg/m <sup>3</sup>
	/		- /	0.009mg/m <sup>3</sup>
			-	0.004mg/m <sup>3</sup>
				0.004mg/m <sup>3</sup>
			0.01mg/m <sup>3</sup>	
		HJ 533-2009		0.01mg/m <sup>3</sup>
		(2003)	( ) (B)	0.001mg/m <sup>3</sup>
		HJ 57-2017	( 50 mol/mol )	2mg/m <sup>3</sup>
		HJ 693-2014		2mg/m <sup>3</sup>
		HJ/T 398-2007		/

		HJ/T 30-1999		0.2mg/m <sup>3</sup>
		HJ 549-2016		0.2mg/m <sup>3</sup>
		HJ/T 27-1999		0.9mg/m <sup>3</sup>
	VOCs( )	HJ 604-2017	-	0.07mg/m <sup>3</sup>
		HJ 644-2013	- / -	0.4 g/m <sup>3</sup>
				0.4 g/m <sup>3</sup>
				0.3 g/m <sup>3</sup>
	/			0.6 g/m <sup>3</sup>
				0.6 g/m <sup>3</sup>
				0.6 g/m <sup>3</sup>
		HJ/T 30-1999		0.03mg/m <sup>3</sup>
		HJ 549-2016		0.02mg/m <sup>3</sup>
		GB/T 15432-1995		0.001mg/m <sup>3</sup>
		HJ 479-2009	) (	0.005mg/m <sup>3</sup>
		HJ 533-2009		0.01mg/m <sup>3</sup>
		(2003)	) ( (B)	0.001mg/m <sup>3</sup>
		GB/T 14675-1993		10( )

---

pH	HJ 1147-2020	pH	/
	HJ 828-2017		4 mg/L
	HJ 505-2009	(BOD <sub>5</sub> )	0.5mg/L
	GB/T 11901-1989		/
	HJ 1182-2021		2
	HJ 535-2009		0.025 mg/L
	HJ 636-2012		0.05mg/L
	GB/T 11893-1989		0.01mg/L
	HJ 503-2009	4-	0.01mg/L
	GB/T 11896-1989		10mg/L
	HJ 501-2009		0.1mg/L

		GB/T 17141-1997		0.01 mg/kg
		HJ 1082-2019	-	0.5mg/kg
		HJ 491-2019		4mg/kg
				1mg/kg
				3mg/kg
				1mg/kg
				10mg/kg
		HJ 605-2011	/ -	1.0 g/kg
				1.0 g/kg
	1,1-			1.0 g/kg
				1.5 g/kg
	-1,2-			1.4 g/kg
	1,1-			1.2 g/kg
	-1,2-			1.3 g/kg
				1.1 g/kg
	1,2-			1.3 g/kg
	1,1,1-			1.3 g/kg
				1.3 g/kg
				1.9 g/kg
	1,2-			1.1 g/kg
				1.2 g/kg
	1,1,2-			1.2 g/kg
				1.3 g/kg
				1.4 g/kg
	1,1,1,2-			1.2 g/kg
				1.2 g/kg
				1.2 g/kg
	/	1.2 g/kg		
		HJ 605-2011	/ -	1.1 g/kg
	1,2,3-			1.2 g/kg
				1.2 g/kg
	1,1,2,2-			1.2 g/kg
	1,4-			1.5 g/kg
	1,2-			1.5 g/kg

			0.4 g/kg
			0.09 mg/kg
			0.09 mg/kg
2-			0.06 mg/kg
[a]			0.1 mg/kg
[a]	HJ 834-2017		0.1 mg/kg
[b]		-	0.2 mg/kg
[k]			0.1 mg/kg
			0.1 mg/kg
[a, h]			0.1 mg/kg
[1,2,3-cd]			0.1 mg/kg
(C <sub>10</sub> -C <sub>40</sub> )	HJ 1021-2019	(C <sub>10</sub> -C <sub>40</sub> )	6mg/kg
pH	HJ 962-2018	pH	/
	NY/T		

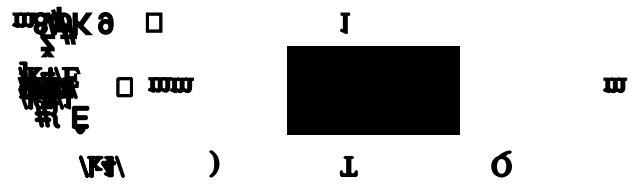

	GB/T 5750.5-2006		N N-	0.005mg/L
	GB/T 11904-1989			0.01mg/L
	GB/T 5750.12-2006		(2.1)	/
	GB/T 5750.12-2006		(1.1)	/
( N )	GB/T 5750.5-2006			0.001mg/L
( N )	GB/T 7480-1987		Ca <sup>2+</sup>	0.02mg/L
5	GB/T 5750.5-2006		-	0.002mg/L
	GB/T 5750.5-2006		(3.1)	0.2mg/L
	HJ 694-2014			0.04 g/L
				0.3 g/L
	GB/T 5750.6-2006	(9.1	)	0.5 g/L
	GB/T 5750.6-2006			0.004mg/L
	GB/T 5750.6-2006	(11.1	)	2.5 g/L
				1.4 g/L
	HJ 639-2012		/ -	2.2 g/L
				1.4 g/L
				0.6 g/L
	GB/T 11904-1989			0.05mg/L
	GB/T 11905-1989		SD <sub>0.02</sub> 0.05	0.02mg/L
CO <sub>3</sub> <sup>2-</sup>	GB/T 5750.5-2006		2002 ( )	0.002mg/L
				/
HCO <sub>3</sub> <sup>-</sup>	--			/

			/
	AA-6880F/AAC	ZZHJA12	2021/5/24
pH ( )	P611	ZZHJA24-07	2021/10/12
pH	PHS-3CW	ZZHJA17	2021/4/30
	T6	ZZHJA30-01 02	2021/5/8
	TU-1810PC	ZZHJA31-01 02	2021/5/8
	PF32	ZZHJA33	2021/5/8
TOC	multi N/C 2100S HT 1300	ZZHJA36	2021/5/8
	7890B	ZZHJA37	2020/9/27
-	7890B 5977B	ZZHJA39	2020/9/27
	7820A	ZZHJA40	2020/10/13
	Eco IC	ZZHJA41	2020/10/13
-	8860 5977B	ZZHJA54	2021/7/30
	AR2140	ZZHJB01	2021/5/8
	AUW120D	ZZHJB02	2021/5/8
	YP2102	ZZHJB03	2021/5/8
	WS150III	ZZHJD31	2021/5/8
	LG30	ZZHJE08-03	/
	AWA6228+	ZZHJF22-05	2021/5/8
	EM300	ZZHJF29-01 03	2021/5/8
/	MH1205	ZZHJF32-09 12	2021/10/27
	ZR-3712	ZZHJF34-01 04	2021/8/30
/	3012H-C	ZZHJF36	2021/9/18

			/	/
	MH3300	YQ-AX148	2021.08.27-2022.08.26	
( )	YQ3000-D	YQ-AX112	2021.10.13-2022.10.12	
	3023	YQ-AX012	2021.10.13-2022.10.12	
	QCS-6000	YQ-AX104	2021.10.13-2022.10.12	
	TU-1810ASP C	YQ-AF031	2021.10.13-2022.10.12	
	DZB-712	YQ-AX194	2022.01.11-2023.01.10	
	TAS-990	YQ-AF071	2020.10.14-2022.10.13	
	PF31	YQ-AF072	2021.10.13-2022.10.12	

			/	/
	PXSJ-216F	YQ-AF029	2021.10.13-2022.10.12	
-	GCMS- QP2010SE	YQ-AF047	2020.10.14-2022.10.13	
	PHS-3C	YQ-AF024	2021.10.13-2022.10.12	
	FA2204N	YQ-AF039	2021.10.15-2022.10.14	
	ES1055A	YQ-AF051	2021.10.15-2022.10.14	
	SPX-150B-Z	YQ-AF093	2021.10.18-2022.10.17	



5% (30 70%)  
 ) 8.2-1  
 10% 100 d □  
 I  
 10% 3  
 8.2-2  
 8.2-3 8.2-4

		(L/min)	(%)
ZZHJF29-01	2021.11.21	1.0	1.6
	2021.12.03	1.0	1.2
ZZHJF29-03	2021.11.21	1.01	1.3
	2021.12.03	1.0	0.9
		1.0	0.6
		1.0	1.2
	2021.11.21	1.0	1.7
		1.0	1.3
/ ZZHJF32-09		100	0.7



				(L/min)	(%)		
		2021.12.03		100	1.5		
				1.0	0.6		
				1.0	1.2		
				1.0	1.7		
				1.0	0.9		
				100	1.5		
/	ZZHJF32-11	2021.11.21		1.0	2.1		
				1.0	1.7		
				1.0	1.4		
				1.0	1.8		
				100	1.4		
				1.0	1.3		
			2021.12.03		1.0	1.9	
				1.0	1.4		
				1.0	1.7		
				1.0	1.4		
/	ZZHJF32-11	2021.12.03		100	1.3		
				1.0	0.7		
	ZZHJF32-12	2021.11.21			1.0	1.2	
					1.0	1.5	
					1.0	1.7	
					100	1.3	
		2021.12.03			1.0	2.1	
					1.0	1.5	
					1.0	1.9	
					1.0	1.6	
			100	1.3			
	ZZHJF34-01	2021.11.21			1.0	1.7	
					1.0	1.3	
					1.0	1.1	
				1.0	1.2		
2021.12.03					1.0	1.5	
					1.0	2.1	
					1.0	1.5	
					1.0	1.4	
ZZHJF34-04	2021.11.21			1.0	1.5		
	2021.12.03			1.0	1.4		
/	ZZHJF36	2021.11.21		20	2.3		

				(L/min)	(%)	
		2021.12.03		40	1.7	
				50	1.5	
				20	1.3	
				40	1.7	
				50	2.1	
/	ZZHJF35-02	2021.11.21		20	2.4	
				40	2.1	
				50	1.6	
		2021.12.03		20	1.5	
				40	1.7	
				50	2.1	

		/			YQ-AX174		
/		L/min	L/min		(%)	(%)	
( ) 2022.03.21	YQ-AX112	20.0	20.1	20.2	0.2	5	
		40.0	40.2	40.1	0.1	5	
		50.0	50.1	50.2	0.1	5	
2022.03.21	YQ-AX148	20.0	20.2	20.1	0.2	5	
		40.0	40.2	40.1	0.1	5	
		50.0	50.2	50.1	0.1	5	
( ) 2022.03.22	YQ-AX112	20.0	20.1	20.2	0.2	5	
		40.0	40.2	40.0	0.2	5	
		50.0	50.1	50.3	0.2	5	
2022.03.22	YQ-AX148	20.0	20.1	20.2	0.2	5	
		40.0	40.2	40.1	0.1	5	
		50.0	50.1	50.2	0.1	5	

		/			YQ-AX174		
/		mL/min	mL/min		(%)	(%)	
2022.03.21	YQ-AX104	100.0	100.1	100.3	0.1	5	
2022.03.22	YQ-AX104	100.0	100.1	100.3	0.1	5	

		(mg/m <sup>3</sup> )	(%)	(%)	
	VOCs( )	0.07	5	1	
			7		
			7		
		0.07	1	6	
			3		
			6		
	VOCs( )	0.07	1	6	
			1		
			3		

	(mg/m <sup>3</sup> )	1.0	/	
		1.0		
	(mg/m <sup>3</sup> )	0.01	0.01	
		0.01	0.01	
		0.01	0.01	
	(mg/m <sup>3</sup> )	0.004	0.004	
		0.004	0.004	
		0.004	0.004	
	(mg/m <sup>3</sup> )	0.004	0.004	
		0.004	0.004	
		0.004	0.004	
	(mg/m <sup>3</sup> )	0.006	0.006	
		0.006	0.006	
		0.006	0.006	
	/	0.009	0.009	

	(mg/m <sup>3</sup> )	0.009	0.009	
		0.009	0.009	
	(mg/m <sup>3</sup> )	0.004	0.004	
		0.004	0.004	
		0.004	0.004	
	(mg/m <sup>3</sup> )	0.004	0.004	
		0.004	0.004	
		0.004	0.004	
	(mg/m <sup>3</sup> )	0.2	0.2	
		0.2		
		0.2	0.2	
		0.2		
	(mg/m <sup>3</sup> )	0.001	/	
		0.001		
	(mg/m <sup>3</sup> )	0.25	/	
		0.25		
		0.25		
	(mg/m <sup>3</sup> )	0.2	0.2	
		0.2		
		0.2	0.2	
		0.2		
	(mg/m <sup>3</sup> )	0.001	/	
		0.001		
	(mg/m <sup>3</sup> )	0.001	/	
		0.001		
	(mg/m <sup>3</sup> )	0.01	/	
		0.01		

FQ2203-22D-015		mg/m <sup>3</sup>	ND
FQ2203-22D-011		mg/m <sup>3</sup>	ND
FQ2203-22D-007		mg/m <sup>3</sup>	ND
( )		mg/m <sup>3</sup>	ND
		mg/m <sup>3</sup>	ND
		mg/m <sup>3</sup>	ND

	( g/m <sup>3</sup> )	0.4	0.4
		0.4	

	( g/m <sup>3</sup> )	0.4	0.4	
		0.4		
	( g/m <sup>3</sup> )	0.3	0.3	
		0.3		
	/ ( g/m <sup>3</sup> )	0.6	0.6	
		0.6		
	( g/m <sup>3</sup> )	0.6	0.6	
		0.6		
		0.6	0.6	
		0.6		
(mg/m <sup>3</sup> )	0.005	/		
	0.005			

(GB 12348-2008)

0.5dB

0.5dB

8.2-5

AWA 6228+	ZZHJF 22-05	dB(A)	94.0 ( )	11 23	93.8	0		
				11 23	93.8			
				11 23	93.8	0		
				11 23	93.8			
				11 24	93.8	0		
				11 24	93.8			
				11 24	93.8	0		
				11 24	93.8			

(HJ 91.1-2019)

( ) (HJ/T 373-2007)

10%

8.2-6

8.2-7

	(%)			
		(mg/L)	(mg/L)	
	0	19.0	23.0	19.4
	3			21.6
	1	500	50	478
	1			489
	0	/	/	/
	0			/
	0.5	0.400	0.040	0.418
	0.2			
	0	0.80	0.08	0.81
	0			
	0	3.00	0.30	3.03
	0.4			
	0	1.00	0.1	0.977
	0			0.973
	0	/	/	/
	0			/
	1	50	5	51
	1			
	0.7	/	/	/
	0.7			/

					(%)	
(mg/L)	0.5	0.5	0.5	0.5	/	
(mg/L)	0	0	/	/	/	
(NTU)	2	2	/	/	/	
(mg/L)	4	4	4	4	/	
(mg/L)	0.025	0.025	0.025	0.025	/	
(mg/L)	0.01	0.01	0.01	0.01	/	
(mg/L)	0.05	0.05	0.05	0.05	93	
(mg/L)	0.01	0.01	0.01	0.01	/	
(mg/L)	10	10	10	10	/	
(mg/L)	0.1	0.1	0.1	0.1	/	
(mg/L)	10	10	/	/	/	
	0.4	/	0.4	/	108	
					101	
	0.3	/	0.3	/	111	

						(%)	
						114	
		0.3	/	0.3	/	115	
						87.3	
	/	0.5	/	0.5	/	96.5	
						85.7	
		0.2	/	0.2	/	109	
						95.5	
		0.2	/	0.2	/	111	
						90.0	
		0.3	/	0.3	/	102	
						86.4	

		(%)				
			-D8	4-		
	C1124-1-1a	89.9	117	115		HJ 639-2012
	C1124-1-1b	86.0	117	115		HJ 639-2012
	C1124-1-2	90.1	116	110		HJ 639-2012
	C1124-1-3	86.4	118	113		HJ 639-2012
	C1124-1-4	84.3	118	112		HJ 639-2012
	C1124-2-1	82.3	112	117		HJ 639-2012
	C1124-2-2	87.2	114	119		HJ 639-2012
	C1124-2-3	83.0	117	114		HJ 639-2012
	C1124-2-4	84.0	114	107		HJ 639-2012
	C1125-1-1a	80.2	99.1	113		HJ 639-2012
	C1125-1-1b	93.3	99.2	111		HJ 639-2012
	C1125-1-2	87.9	104	105		HJ 639-2012
	C1125-1-3	90.5	101	115		HJ 639-2012
	C1125-1-4	86.5	115	119		HJ 639-2012
	C1125-2-1	83.6	116	113		HJ 639-2012
	C1125-2-2	82.6	106	109		HJ 639-2012
	C1125-2-3	87.3	105	110		HJ 639-2012
	C1125-2-4	84.0	107	110		HJ 639-2012

(HJ/T 166-2004)

10%

						(%)	
(mg/kg)	<0.01	<0.01	<0.01	<0.01	/	2	
(mg/kg)	<0.002	<0.002	<0.002	<0.002	/	3	
(mg/kg)	<0.01	<0.01	<0.01	<0.01	/	6	
(mg/kg)	<0.5	<0.5	<0.5	<0.5	/	/	
(mg/kg)	<4	<4	<4	<4	/	2	
(mg/kg)	<1	<1	<1	<1	/	2	
(mg/kg)	<3	<3	<3	<3	/	0	
(mg/kg)	<1	<1	<1	<1	/	2	
(mg/kg)	<10	<10	<10	<10	/	3	
( g/kg)	<1.0	<1.0	<1.0	<1.0	<1.0	/	
( g/kg)	<1.0	<1.0	<1.0	<1.0	<1.0	/	
1,1- ( g/kg)	<1.0	<1.0	<1.0	<1.0	<1.0	/	
( g/kg)	<1.5	<1.5	<1.5	<1.5	<1.5	/	
-1,2- ( g/kg)	<1.4	<1.4	<1.4	<1.4	<1.4	/	
1,1- ( g/kg)	<1.2	<1.2	<1.2	<1.2	<1.2	/	
-1,2- ( g/kg)	<1.3	<1.3	<1.3	<1.3	<1.3	/	
( g/kg)	<1.1	<1.1	<1.1	<1.1	<1.1	/	
1,2- ( g/kg)	<1.3	<1.3	<1.3	<1.3	<1.3	/	
1,1,1- ( g/kg)	<1.3	<1.3	<1.3	<1.3	<1.3	/	
( g/kg)	<1.3	<1.3	<1.3	<1.3	<1.3	/	
( g/kg)	<1.9	<1.9	<1.9	<1.9	<1.9	/	
1,2- ( g/kg)	<1.1	<1.1	<1.1	<1.1	<1.1	/	
( g/kg)	<1.2	<1.2	<1.2	<1.2	<1.2	/	
1,1,2- ( g/kg)	<1.2	<1.2	<1.2	<1.2	<1.2	/	
( g/kg)	<1.3	<1.3	<1.3	<1.3	<1.3	/	
( g/kg)	<1.4	<1.4	<1.4	<1.4	<1.4	/	
1,1,1,2- ( g/kg)	<1.2	<1.2	<1.2	<1.2	<1.2	/	
( g/kg)	<1.2	<1.2	<1.2	<1.2	<1.2	/	
( g/kg)	<1.2	<1.2	<1.2	<1.2	<1.2	/	
/ ( g/kg)	<1.2	<1.2	<1.2	<1.2	<1.2	/	
( g/kg)	<1.1	<1.1	<1.1	<1.1	<1.1	/	
1,2,3- ( g/kg)	<1.2	<1.2	<1.2	<1.2	<1.2	/	

				(%)	
( g/kg)					
( g/kg)	<1.2	<1.2	<1.2	/	
1,1,2,2- ( g/kg)	<1.2	<1.2	<1.2	/	
1,4- ( g/kg)	<1.5	<1.5	<1.5	/	
1,2- ( g/kg)	<1.5	<1.5	<1.5	/	
( g/kg)	<0.4	<0.4	<0.4	/	
(mg/kg)	<0.09	<0.09	/	/	
(mg/kg)	<0.09	<0.09	/	/	
2- (mg/kg)	<0.06	<0.06	/	/	
[a] (mg/kg)	<0.1	<0.1	/	/	
[a] (mg/kg)	<0.1	<0.1	/	/	
[b] (mg/kg)	<0.2	<0.2	/	/	
[k] (mg/kg)	<0.1	<0.1	/	/	
(mg/kg)	<0.1	<0.1	/	/	
[a, h] (mg/kg)	<0.1	<0.1	/	/	
[1,2,3-cd] (mg/kg)	<0.1	<0.1	/	/	
(C <sub>10</sub> -C <sub>40</sub> )(mg/kg)	<6	<6	/	/	

		(%)				
			-D8	4-		
	G1125-1a-1a	95.6	113	110		HJ 605-2011
	G1125-1a-1b	80.5	106	101		HJ 605-2011
	G1125-1b-1	84.3	101	106		HJ 605-2011
	G1125-1c-1	81.7	99.4	117		HJ 605-2011
	G1125-2a-1	84.0	118	104		HJ 605-2011
	G1125-2b-1	83.5	116	109		HJ 605-2011
	G1125-2c-1	82.5	115	116		HJ 605-2011

		(%)				
		-D6	-D5	4,4 - -D14		
	G1125-1a-1a	84.9	110	120		HJ 834-2017
	G1125-1a-1b	86.1	109	111		HJ 834-2017
	G1125-1b-1	84.9	106	117		HJ 834-2017

		(%)				
		-D6	-D5	4,4 - -D14		
	G1125-1c-1	89.9	113	111		HJ 834-2017
	G1125-2a-1	88.6	112	119		HJ 834-2017
	G1125-2b-1	91.0	114	110		HJ 834-2017
	G1125-2c-1	92.7	115	110		HJ 834-2017

		(%)		
		101		HJ 1082-2019
		100		HJ 834-2017
		98.2		HJ 834-2017
	2-	100		HJ 834-2017
	[a]	101		HJ 834-2017
	[a]	101		HJ 834-2017
	[b]	102		HJ 834-2017
	[k]	102		HJ 834-2017
		101		HJ 834-2017
	[a, h]	101		HJ 834-2017
	[1,2,3-cd]	97.4		HJ 834-2017

(mg/kg)	10.6	0.8	10.5	
(mg/kg)	0.052	0.006	0.054	
(mg/kg)	0.13	0.01	0.12	
(mg/kg)	65	2	64	
(mg/kg)	65	3	64	
(mg/kg)	28.5	1.2	29.5	
(mg/kg)	21.6	0.8	22.4	
(mg/kg)	21.6	1.2	21.9	

8.2-12 8.2-16

						(%)
DX2203-21D-001		mg/L	450	448	449	0.22

						(%)
DX2203-22D-001			447	445	446	0.22
DX2203-21D-001		mg/L	676	680	678	0.30
DX2203-22D-001			672	668	670	0.30
DX2203-21D-001		mg/L	483	485	484	0.21
DX2203-22D-001			521	525	523	0.38
DX2203-21D-003		mg/L	144	143	144	0.35
DX2203-22D-003			153	152	152	0.33
DX2203-22D-016		mg/L	0.008L	0.008L	0.008L	/
DX2203-21D-005		mg/L	0.02	0.02	0.02	0.00
DX2203-21D-002		mg/L	0.0003L	0.0003L	0.0003L	/
DX2203-22D-002			0.0003L	0.0003L	0.0003L	/
DX2203-21D-001		mg/L	1.80	1.84	1.83	1.10
DX2203-22D-001			1.84	1.88	1.86	1.08
DX2203-21D-001		mg/L	0.11	0.12	0.12	4.35
DX2203-22D-001			0.13	0.14	0.14	3.70
DX2203-21D-006		mg/L	0.005L	0.005L	0.005L	/
DX2203-22D-006			0.005L	0.005L	0.005L	/
DX2203-21D-005		mg/L	63.1	63.8	63.4	0.55
DX2203-21D-003	( N )	mg/L	0.001L	0.001L	0.001L	/
DX2203-22D-003			0.001L	0.001L	0.001L	/
DX2203-22D-003	( N )	mg/L	6.79	6.77	6.78	0.15
DX2203-21D-002		mg/L	0.002L	0.002L	0.002L	/
DX2203-22D-002			0.002L	0.002L	0.002L	/
DX2203-21D-003		mg/L	0.4	0.4	0.4	0.00
DX2203-22D-003			0.4	0.4	0.4	0.00

						(%)
DX2203-21D-005		g/L	0.08	0.08	0.08	0.00
DX2203-22D-024			0.08	0.07	0.08	6.67
DX2203-21D-024		g/L	0.3L	0.3L	0.3L	/
DX2203-22D-024			0.3L	0.3L	0.3L	/
DX2203-21D-005		g/L	0.5L	0.5L	0.5L	/
DX2203-22D-032		g/L	2.5L	2.5L	2.5L	/
DX2203-21D-005		mg/L	0.004L	0.004L	0.004L	/
DX2203-22D-005			0.004L	0.004L	0.004L	/
DX2203-22D-016		mg/L	2.35	2.35	2.35	0.00
DX2203-21D-005		mg/L	270	283	276	2.35
		mg/L	49.5	48.8	49.2	0.71
DX2203-21D-007	CO <sub>3</sub> <sup>2-</sup>	mmol/L	0	0	0	0.00
DX2203-22D-007			0	0	0	0.00
DX2203-21D-007	HCO <sub>3</sub> <sup>-</sup>	mmol/L	3.11	3.09	3.10	0.32
DX2203-22D-007			3.10	3.08	3.09	0.32
+L						

( )		mg/L	5L
		mg/L	0.01L
		mg/L	0.008L
		mg/L	0.01L
		mg/L	0.0003L
		mg/L	0.02L
		mg/L	0.005L
		mg/L	0.01L
( )		MPN/100mL	
		CFU/mL	
	( N )	mg/L	0.0011
	( N )	mg/L	0.021
		mg/L	0.0021
		g/L	0.04L

		g/L	0.3L
		g/L	0.5L
		mg/L	0.004L
		g/L	2.5L
		mg/L	0.05L
		mg/L	0.02L
		mg/L	0.002L
	ND	+L	

DX2203-21D-011		g/L	1.4L
		g/L	2.2L
		g/L	1.4L
		g/L	0.6L
DX2203-22D-011		g/L	1.4L
		g/L	2.2L
		g/L	1.4L
		g/L	0.6L
			+L

DX2203-21D-010		g/L	1.4L
		g/L	2.2L
		g/L	1.4L
		g/L	0.6L
DX2203-22D-010		g/L	1.4L
		g/L	2.2L
		g/L	1.4L
		g/L	0.6L
			+L

	( g/kg)				(%)	
DX2203-21D-009		1.4L	1.4L	1.4L	/	
		2.2L	2.2L	2.2L	/	
		1.4L	1.4L	1.4L	/	
		0.6L	0.6L	0.6L	/	
DX2203-22D-009		1.4L	1.4L	1.4L	/	
		2.2L	2.2L	2.2L	/	
		1.4L	1.4L	1.4L	/	

---

	( g/kg)				(%)	
		0.6L	0.6L	0.6L	/	
	+L					

9.1-1

2021.11.22	2021.12.02	1		5500 t/a	19.5 t/d	4680 t/a	85.1%
2021.11.22	2021.12.02	2	PVAC	3000 t/a	10.5 t/d	2520 t/a	84.0%
2021.11.22	2021.12.02	3		1000 t/a	3.5 t/d	840 t/a	84.0%
2021.11.22	2021.12.02	4		3000 t/a	10.8 t/d	2592 t/a	86.4%
2021.11.22	2021.12.02	5		1500 t/a	5.4 t/d	1296 t/a	86.4%
2021.11.22	2021.12.02	6		2000 t/a	7.0 t/d	1680 t/a	84.0%
2021.11.22	2021.12.02	7		2500 t/a	8.5 t/d	2040 t/a	81.6%
2021.11.22	2021.12.02	8		1000 t/a	3.5 t/d	840 t/a	84.0%
2021.11.22	2021.12.02	9		3000 t/a	10.5 t/d	2520 t/a	84.0%
2021.11.22	2021.12.02	1		60 t/a	0.212 t/d	50.9 t/a	84.8%
2021.11.22	2021.12.02	2		10 t/a	0.036 t/d	8.6 t/a	86.4%

2022.3.21	2022.3.22	1		5500 t/a	19.2 t/d	4608 t/a	83.8%
2022.3.21	2022.3.22	2	PVAC	3000 t/a	10.8 t/d	2592 t/a	86.4%
2022.3.21	2022.3.22	3		1000 t/a	3.5 t/d	840 t/a	84.0%
2022.3.21	2022.3.22	4		3000 t/a	10.6 t/d	2544 t/a	84.8%
2022.3.21	2022.3.22	5		1500 t/a	5.4 t/d	1296 t/a	86.4%
2022.3.21	2022.3.22	6		2000 t/a	7.2 t/d	1728 t/a	86.4%
2022.3.21	2022.3.22	7		2500 t/a	8.9 t/d	2136 t/a	85.4%
2022.3.21	2022.3.22	8		1000 t/a	3.6 t/d	864 t/a	86.4%
2022.3.21	2022.3.22	9		3000 t/a	10.8 t/d	2592 t/a	86.4%
2022.3.21	2022.3.22	1		60 t/a	0.208 t/d	49.9 t/a	83.2%
2022.3.21	2022.3.22	2		10 t/a	0.036 t/d	8.6 t/a	86.4%

---

1

(mg/m <sup>3</sup> )	0.01	0.01	0.03
VOCs( ) (mg/m <sup>3</sup> )	31.4	40.4	43.8
( )	29	29	29
(m <sup>3</sup> /h)	15926	15699	15647
(m/s)	13.0	12.8	12.8
		/	0.7m
2021.11.24			
(mg/m <sup>3</sup> )	0.118	0.097	0.077
(mg/m <sup>3</sup> )	0.412	0.316	0.067
(mg/m <sup>3</sup> )	0.01	<0.01	<0.01
VOCs( ) (mg/m <sup>3</sup> )	42.5	39.3	42.2
( )	29	29	29
(m <sup>3</sup> /h)	15773	15173	15668
(m/s)	12.9	12.4	12.8
		25m	0.8m
2021.11.23			
(mg/m <sup>3</sup> )	0.049	0.040	0.147
(kg/h)	7.94 10 <sup>-4</sup>	6.58 10 <sup>-4</sup>	2.37 10 <sup>-3</sup>
(mg/m <sup>3</sup> )	0.093	0.089	0.074
(kg/h)	1.51 10 <sup>-3</sup>	1.46 10 <sup>-3</sup>	1.19 10 <sup>-3</sup>
(mg/m <sup>3</sup> )	<0.01	<0.01	<0.01
(kg/h)	0	0	0
VOCs( ) (mg/m <sup>3</sup> )	2.58	2.52	2.13
(kg/h)	0.0418	0.0415	0.0344
( )	17.2	17.2	17.3
(m <sup>3</sup> /h)	16212	16453	16145
(m/s)	9.7	9.8	9.7
		25m	0.8m
2021.11.24			
(mg/m <sup>3</sup> )	0.105	0.018	0.075
(kg/h)	1.70 10 <sup>-3</sup>	2.91 10 <sup>-4</sup>	1.22 10 <sup>-3</sup>
(mg/m <sup>3</sup> )	0.054	ND	0.037
(kg/h)	8.75 10 <sup>-4</sup>	0	6.04 10 <sup>-4</sup>
(mg/m <sup>3</sup> )	<0.01	<0.01	<0.01
(kg/h)	0	0	1.63 10 <sup>-4</sup>
VOCs( ) (mg/m <sup>3</sup> )	2.59	2.45	2.05
(kg/h)	0.0420	0.0396	0.0335

( )	17.4	9.7	17.3
(m <sup>3</sup> /h)	16210	16169	16319
(m/s)	9.7	9.7	9.8
ND			

			/		0.8m
2021.11.22					
(mg/m <sup>3</sup> )	<0.004	<0.004			<0.004
VOCs( ) (mg/m <sup>3</sup> )	40.2	39.8			45.7
(mg/m <sup>3</sup> )	0.90	1.00			0.97
( )	11.9	12.0			10.5
(m <sup>3</sup> /h)	18853	18280			17689
(m/s)	11.1	10.8			10.3
			/		0.8m
2021.11.23					
(mg/m <sup>3</sup> )	0.043	0.153			0.028
VOCs( ) (mg/m <sup>3</sup> )	43.4	42.2			36.2
(mg/m <sup>3</sup> )	0.83	0.99			1.05
( )	9.9	10.1			10.4
(m <sup>3</sup> /h)	18179	18750			20145
(m/s)	10.4	10.8			11.6
			25m		0.8m
2021.11.22					
(mg/m <sup>3</sup> )	<0.004	<0.004			<0.004
(kg/h)	0	0			0
VOCs( ) (mg/m <sup>3</sup> )	2.65	2.92			2.83
(kg/h)	0.0464	0.0548			0.0544
(mg/m <sup>3</sup> )	0.44	0.66			0.69
(kg/h)	7.70 10 <sup>-3</sup>	0.0124			0.0133
( )	9.1	9.1			9.2
(m <sup>3</sup> /h)	17499	18784			19224
(m/s)	9.9	10.7			10.9
			25m		0.8m
2021.11.23					
(mg/m <sup>3</sup> )	<0.004	0.042			0.022

(kg/h)	0	7.96 10 <sup>-4</sup>	4.23 10 <sup>-4</sup>
VOCs( ) (mg/m <sup>3</sup> )	2.87	2.75	2.77
(kg/h)	0.0515	0.0521	0.0532
(mg/m <sup>3</sup> )	0.35	0.62	0.70
(kg/h)	6.29 10 <sup>-3</sup>	0.0117	0.0135
( )	9.8	9.8	9.9
(m <sup>3</sup> /h)	17961	18945	19221
(m/s)	10.4	11.0	11.2

(m)	27					
	2022.03.21			2022.03.22		
(%)	3.2	3.2	3.2	3.2	3.2	3.2
(%)	21.0	20.8	20.9	20.8	20.9	20.8
(m/s)	3.3	3.3	3.2	3.2	3.4	3.5
( )	13.7	17.3	17.1	19.9	22.8	24.4
(m <sup>2</sup> )	0.332			0.332		
(m <sup>3</sup> /h)	3633	3589	3483	3449	3629	3714
NO (mg/m <sup>3</sup> )	5	4	6	3	3	5
NO (kg/h)	0.018	0.014	0.021	0.010	0.011	0.019
(mg/m <sup>3</sup> )	4.73	4.61	4.55	4.87	4.75	4.58
(kg/h)	0.017	0.017	0.019	0.017	0.017	0.017
(mg/m <sup>3</sup> )	1.08	1.12	1.15	1.07	1.16	1.14
(kg/h)	0.004	0.004	0.004	0.004	0.004	0.004
(mg/m <sup>3</sup> )	5.1	5.7	4.9	5.8	5.6	5.0
(kg/h)	0.019	0.020	0.017	0.020	0.020	0.019

		/	0.4m
	2021.11.22		
VOCs( ) (mg/m <sup>3</sup> )	48.5	48.2	49.5
(mg/m <sup>3</sup> )	0.021	0.047	0.044
(mg/m <sup>3</sup> )	0.083	0.099	0.090
(mg/m <sup>3</sup> )	0.010	0.025	0.018
/ (mg/m <sup>3</sup> )	<0.009	0.034	0.026

(mg/m <sup>3</sup> )	0.009	0.009	0.010
(mg/m <sup>3</sup> )	0.017	0.034	0.025
(mg/m <sup>3</sup> )	0.140	0.248	0.213
(mg/m <sup>3</sup> )	0.506	0.510	0.508
(mg/m <sup>3</sup> )	0.92	1.06	1.05
( )	9.77 10 <sup>3</sup>	1.74 10 <sup>4</sup>	1.32 10 <sup>4</sup>
( )	10.3	10.9	10.7
(m <sup>3</sup> /h)	5517	5560	5623
(m/s)	13.0	13.1	13.2
		/	0.4m
2021.11.23			
VOCs( ) (mg/m <sup>3</sup> )	50.2	50.3	51.0
(mg/m <sup>3</sup> )	0.006	0.015	0.013
(mg/m <sup>3</sup> )	0.100	0.020	0.100
(mg/m <sup>3</sup> )	0.008	<0.006	<0.006
/ (mg/m <sup>3</sup> )	<0.009	<0.009	<0.009
(mg/m <sup>3</sup> )	0.004	<0.004	<0.004
(mg/m <sup>3</sup> )	0.015	0.009	0.009
(mg/m <sup>3</sup> )	0.133	0.044	0.122
(mg/m <sup>3</sup> )	0.508	0.506	0.507
(mg/m <sup>3</sup> )	0.93	1.16	1.10
( )	1.32 10 <sup>4</sup>	1.32 10 <sup>4</sup>	1.74 10 <sup>4</sup>
( )	9.3	9.4	9.4
(m <sup>3</sup> /h)	5773	5109	5517
(m/s)	13.2	11.7	12.6
		25m	0.5m
2021.11.22			
VOCs( ) (mg/m <sup>3</sup> )	3.16	3.31	3.42
(kg/h)	0.0175	0.0183	0.0190
(mg/m <sup>3</sup> )	0.018	0.043	0.038
(kg/h)	9.95 10 <sup>-5</sup>	2.37 10 <sup>-4</sup>	2.11 10 <sup>-4</sup>
(mg/m <sup>3</sup> )	0.075	0.042	0.062
(kg/h)	4.15 10 <sup>-4</sup>	2.32 10 <sup>-4</sup>	3.44 10 <sup>-4</sup>
(mg/m <sup>3</sup> )	0.007	0.012	0.011
(kg/h)	3.87 10 <sup>-5</sup>	6.62 10 <sup>-5</sup>	6.10 10 <sup>-5</sup>
/ (mg/m <sup>3</sup> )	<0.009	0.015	0.011
(kg/h)	0	8.28 10 <sup>-5</sup>	6.10 10 <sup>-5</sup>
(mg/m <sup>3</sup> )	<0.004	<0.004	<0.004
(kg/h)	0	0	0

(mg/m <sup>3</sup> )	0.014	0.020	0.018
(kg/h)	7.74 10 <sup>-5</sup>	1.10 10 <sup>-4</sup>	9.98 10 <sup>-5</sup>
(mg/m <sup>3</sup> )	0.114	0.132	0.140
(kg/h)	6.30 10 <sup>-4</sup>	7.28 10 <sup>-4</sup>	7.76 10 <sup>-4</sup>
(mg/m <sup>3</sup> )	0.011	0.009	0.010
(kg/h)	6.08 10 <sup>-5</sup>	4.97 10 <sup>-5</sup>	5.55 10 <sup>-5</sup>
(mg/m <sup>3</sup> )	0.47	0.65	0.46
(kg/h)	2.60 10 <sup>-3</sup>	3.59 10 <sup>-3</sup>	2.55 10 <sup>-3</sup>
( )	417	550	550
( )	10.4	10.5	10.5
(m <sup>3</sup> /h)	5527	5517	5545
(m/s)	8.2	8.2	8.3
		25m	0.5m
	2021.11.23		
VOCs( )	3.25	3.27	3.10
(mg/m <sup>3</sup> )			
(kg/h)	0.0170	0.0169	0.0167
(mg/m <sup>3</sup> )	<0.004	0.012	0.013
(kg/h)	0	6.21 10 <sup>-5</sup>	7.01 10 <sup>-5</sup>
(mg/m <sup>3</sup> )	0.008	0.013	<0.004
(kg/h)	4.18 10 <sup>-5</sup>	6.73 10 <sup>-5</sup>	0
(mg/m <sup>3</sup> )	<0.006	<0.006	<0.006
(kg/h)	0	0	0
/	<0.009	<0.009	<0.009
(mg/m <sup>3</sup> )			
(kg/h)	0	0	0
(mg/m <sup>3</sup> )	<0.004	<0.004	<0.004
(kg/h)	0	0	0
(mg/m <sup>3</sup> )	0.007	0.007	<0.004
(kg/h)	3.66 10 <sup>-5</sup>	3.62 10 <sup>-5</sup>	0
(mg/m <sup>3</sup> )	0.015	0.039	0.013
(kg/h)	7.84 10 <sup>-5</sup>	2.02 10 <sup>-4</sup>	7.01 10 <sup>-5</sup>
(mg/m <sup>3</sup> )	0.012	0.011	0.010
(kg/h)	6.27 10 <sup>-5</sup>	5.69 10 <sup>-5</sup>	5.39 10 <sup>-5</sup>
(mg/m <sup>3</sup> )	0.49	0.56	0.62
(kg/h)	2.56 10 <sup>-3</sup>	2.90 10 <sup>-3</sup>	3.34 10 <sup>-3</sup>
( )	417	417	550
( )	8.1	8.1	8.2
(m <sup>3</sup> /h)	5225	5175	5392
(m/s)	7.7	7.6	8.0

		18m	0.6m
	2021.11.25		

(mg/m <sup>3</sup> )	2.1	2.3	2.2	2.4	2.1	2.4
(kg/h)	7.69 10 <sup>-3</sup>		7.45 10 <sup>-3</sup>		6.96 10 <sup>-3</sup>	
(mg/m <sup>3</sup> )	<2	<2	<2	<2	<2	<2
(kg/h)	0		0		0	
(mg/m <sup>3</sup> )	7	8	13	14	27	28
(kg/h)	0.0256		0.0440		0.0894	
( )	<1		<1		<1	
( )	72.6		77.7		79.1	
(m <sup>3</sup> /h)	3663		3386		3312	
(m/s)	4.5		4.6		4.6	
(%)	5.0		4.9		5.9	
				18m		0.6m
				2021.11.30		
(mg/m <sup>3</sup> )	2.4	2.4	2.2	2.3	2.3	2.4
(kg/h)	8.63 10 <sup>-3</sup>		7.19 10 <sup>-3</sup>		7.46 10 <sup>-3</sup>	
(mg/m <sup>3</sup> )	4	4	<2	<2	<2	<2
(kg/h)	0.0144		0		0	
(mg/m <sup>3</sup> )	38	37	31	32	33	34
(kg/h)	0.137		0.101		0.107	
( )	<1		<1		<1	
( )	79.9		76.3		78.8	
(m <sup>3</sup> /h)	3594		3269		3242	
(m/s)	5.0		4.5		4.5	
(%)	2.6		4.0		4.1	

			P1 ( )			
			VOCs( )			
			(m <sup>3</sup> /h)	(mg/m <sup>3</sup> )	(kg/h)	%
2021.11.23	1		15926	31.4	0.5001	91.6
			16212	2.58	0.0418	
	2		15699	40.4	0.6342	93.5
			16453	2.52	0.0415	
	3		15647	43.8	0.6853	95.0
			16145	2.13	0.0344	
2021.11.24	1		15773	42.5	0.670	93.7
			16210	2.59	0.042	
	2		15173	39.3	0.5963	93.4
			16169	2.45	0.0396	
	3		15668	42.2	0.6612	94.9
			16319	2.05	0.0335	

			P2 ( )						
			VOCs( )						
			(m <sup>3</sup> /h)	(mg/m <sup>3</sup> )	(kg/h)	%	(mg/m <sup>3</sup> )	(kg/h)	%
2021.11.22	1		18853	40.2	0.7579	93.9	0.9	0.0170	54.7
			17499	2.65	0.0464		0.44	7.70 10 <sup>-3</sup>	
	2		18280	39.8	0.7275	92.5	1	0.0183	32.2
			18784	2.92	0.0548		0.66	0.0124	
	3		17689	45.7	0.8084	93.3	0.97	0.0172	22.7
			19224	2.83	0.0544		0.69	0.0133	
2021.11.23	1		18179	43.4	0.789	93.5	0.83	0.0151	58.3
			17961	2.65	0.0515		0.35	6.29 10 <sup>-3</sup>	
	2		18750	42.2	0.7913	93.4	0.99	0.0186	37.1
			18945	2.92	0.0521		0.62	0.0117	
	3		20145	36.2	0.729249	92.7	1.05	0.0212	36.3
			19221	2.83	0.0532		0.7	0.0135	

			( )						
			VOCs( )						
			(m <sup>3</sup> /h)	(mg/m <sup>3</sup> )	(kg/h)	%	(mg/m <sup>3</sup> )	(kg/h)	%
2021.11.22	1		5517	48.5	0.2676	93.5	0.506	0.0028	98.2
			5527	3.16	0.0175		0.011	4.97 10 <sup>-5</sup>	
	2		5560	48.2	0.2680	93.2	0.0028	0.5080	98.0
			5517	3.31	0.0183		6.08 10 <sup>-5</sup>	0.01	
	3		5623	49.5	0.2783	93.2	0.51	0.0029	98.1

			5545	3.42	0.0190		0.009	$5.55 \times 10^{-5}$	
2021. 11.23	1		5773	50.2	0.2898	94.1	0.508	0.0029	97.9
			5225	3.25	0.0170		0.012	$6.27 \times 10^{-5}$	
	2		5109	50.3	0.2570	93.4	0.506	0.0026	97.8
			5175	3.27	0.0169		0.011	$5.69 \times 10^{-5}$	
	3		5517	51	0.2814	94.1	0.507	0.0028	98.1
			5392	3.1	0.0167		0.01	$5.39 \times 10^{-5}$	
			(m <sup>3</sup> /h)	(mg/m <sup>3</sup> )	(kg/h)	%	(mg/m <sup>3</sup> )	(kg/h)	%
2021. 11.22	1		5517	0.92	0.0059	39.2	$9.77 \times 10^3$	/	95.7
			5527	0.47	$3.59 \times 10^{-3}$		417	/	
	2		5560	0.0051	1.0500	56.2	$1.74 \times 10^4$	/	96.8
			5517	$2.60 \times 10^{-3}$	0.4600		550	/	
	3		5623	1.06	0.0059	56.8	$1.32 \times 10^4$	/	95.8
			5545	0.65	$2.55 \times 10^{-3}$		550	/	
2021. 11.23	1		5773	0.93	0.0054	52.6	$1.32 \times 10^4$	/	96.8
			5225	0.49	$2.56 \times 10^{-3}$		417	/	
	2		5109	1.16	0.0059	50.8	$1.32 \times 10^4$	/	96.8
			5175	0.56	$2.90 \times 10^{-3}$		417	/	
	3		5517	1.1	0.0061	45.2	$1.74 \times 10^4$	/	96.8
			5392	0.62	$3.34 \times 10^{-3}$		550	/	

1# VOCs( )  
 ) 0.147mg/m<sup>3</sup> 0.093mg/m<sup>3</sup> 2.59mg/m<sup>3</sup>  
 VOCs( ) 2.37 10<sup>-3</sup>kg/h 1.51 10<sup>-3</sup>kg/h  
 0.042kg/h VOCs( )  
 6 (DB37/2801.6-2018) 1  
 (GB 31572-2015) 4  
 6 (DB37/2801.6-2018)  
 2 GB 37824-2019 1

2# VOCs( )  
 2.92mg/m<sup>3</sup> 0.70mg/m<sup>3</sup> VOCs( )  
 0.0548kg/h 0.0135kg/h VOCs( )

				6		(DB37/2801.6-2018)
1	2					GB 37824-2019
1				(GB 31572-2015)	4	VOCs(
	)				6	
(DB37/2801.6-2018)	1					(GB14554-93)
2						
						1.16mg/m <sup>3</sup>
0.019mg/m <sup>3</sup>	5.8mg/m <sup>3</sup>					
0.004kg/h	0.021kg/h	0.02kg/h	0.017kg/h			
				(DB37/2376-2019)	1	
						(GB31573-2015)
						3
(GB16297-1996)	2					
						VOCs( )
						3.42mg/m <sup>3</sup> 0.14mg/m <sup>3</sup>
0.012mg/m <sup>3</sup>	0.65mg/m <sup>3</sup>	550( )		VOCs( )		
				0.019kg/h	7.76 10 <sup>-4</sup> kg/h	6.27 10 <sup>-5</sup> kg/h
					3.59 10 <sup>-3</sup> kg/h	
VOCs( )						
				( )		
(DB37/3161-2018)	1					
2.4mg/m <sup>3</sup>	4.0mg/m <sup>3</sup>	36mg/m <sup>3</sup>				
	8.63 10 <sup>-3</sup> kg/h	0.0144kg/h	0.137kg/h		<1	SO <sub>2</sub>
NO						(DB37/2374-2018)
2						
2#						3.8mg/m <sup>3</sup>
	0.021kg/h					
(DB37/2376-2019)	1					(GB
31572-2015)	4					GB

---

37824-2019 1

(GB16297-1996) 2

(2)

			( )	(kPa)		(m/s)
2021.12.01			9.8	101.3		0.9
			9.9	101.3		0.8
			8.5	101.3		1.0
			7.9	101.2		1.0
2021.12.02			8.1	101.3		0.8
			8.8	101.3		0.7
			7.5	101.3		0.9
			7.0	101.3		0.9

2021.12.

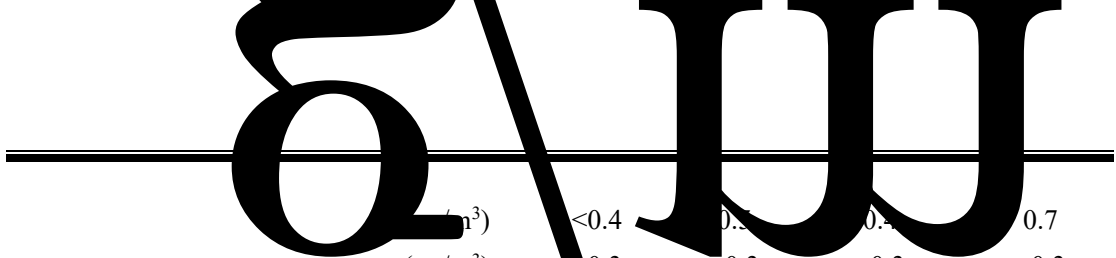

( $\mu\text{m}^3$ )	<0.4	0.2	0.4	0.7
( $\text{g}/\text{m}^3$ )	<0.3	<0.3	<0.3	<0.3
/	<0.6	<0.6	<0.6	<0.6
( $\text{g}/\text{m}^3$ )	<0.6	<0.6	<0.6	<0.6
( $\text{g}/\text{m}^3$ )	<0.6	<0.6	<0.6	<0.6
( $\text{g}/\text{m}^3$ )	ND	ND	ND	ND
( $\text{mg}/\text{m}^3$ )	ND	0.5	0.4	1.1
( $\text{mg}/\text{m}^3$ )	<0.03	<0.03	<0.03	<0.03
( $\text{mg}/\text{m}^3$ )	<0.02	0.172	0.088	0.038
( $\text{mg}/\text{m}^3$ )	0.224	0.328	0.311	0.328
( $\text{mg}/\text{m}^3$ )	0.013	0.022	0.017	0.017
( $\text{mg}/\text{m}^3$ )	0.11	0.11	0.12	0.13
( $\text{mg}/\text{m}^3$ )	<0.001	<0.001	<0.001	<0.001
( )	<10	12	11	12
ND				
VOCs( )( $\text{mg}/\text{m}^3$ )	0.38	1.26	1.07	1.21
( $\text{g}/\text{m}^3$ )	<0.4	<0.4	0.5	<0.4
( $\text{g}/\text{m}^3$ )	0.4	0.5	1.1	<0.4
( $\text{g}/\text{m}^3$ )	<0.3	<0.3	0.6	<0.3
/	<10	15		
( $\text{g}/\text{m}^3$ )	<0.01			

2021.12.01

(  
<0.5  
ND

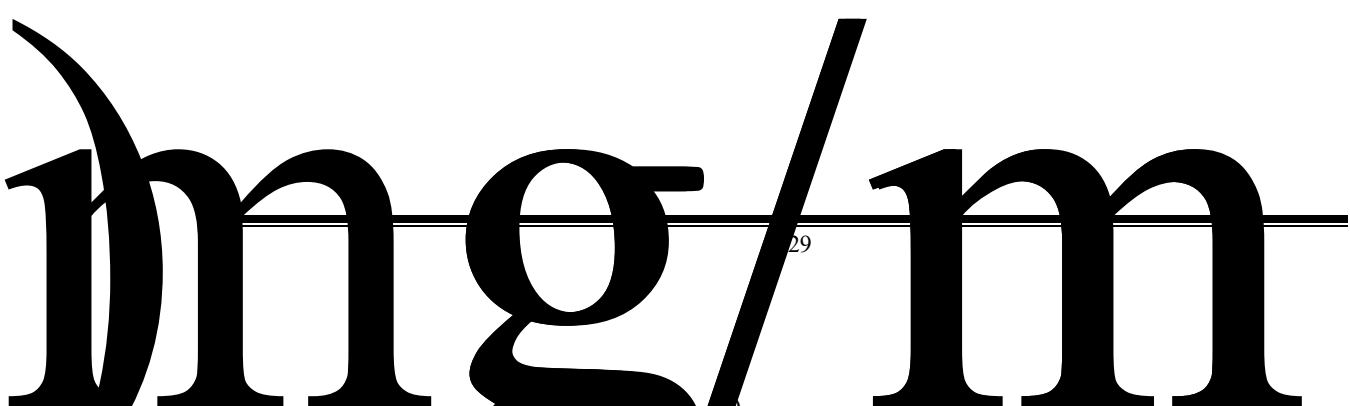

		ND				
2021.12.02	VOCs( )( $\text{mg}/\text{m}^3$ )	0.42	1.18	1.17	1.11	
	( $\text{g}/\text{m}^3$ )	<0.4	<0.4	0.4	<0.4	
	( $\text{g}/\text{m}^3$ )	0.4	0.4	2.4	<0.4	
	( $\text{g}/\text{m}^3$ )	<0.3	<0.3	1.1	<0.3	
	/ ( $\text{g}/\text{m}^3$ )	<0.6	<0.6	3.2	<0.6	
	( $\text{g}/\text{m}^3$ )	<0.6	<0.6	<0.6	<0.6	
	( $\text{g}/\text{m}^3$ )	<0.6	<0.6	1.6	<0.6	
	( $\text{g}/\text{m}^3$ )	ND	ND	4.8	ND	
	( $\text{mg}/\text{m}^3$ )	0.4	0.4	8.7	ND	
	( $\text{mg}/\text{m}^3$ )	<0.03	<0.03	<0.03	<0.03	
	( $\text{mg}/\text{m}^3$ )	<0.02	<0.02	0.037	<0.02	
	( $\text{mg}/\text{m}^3$ )	0.257	0.360	0.360	0.360	
	( $\text{mg}/\text{m}^3$ )	0.012	0.021	0.018	0.015	
	( $\text{mg}/\text{m}^3$ )	0.03	0.10	0.11	0.10	
( $\text{mg}/\text{m}^3$ )	<0.001	<0.001	<0.001	<0.001		
( )	<10	12	12	12		
		ND				
2021.12.02	VOCs( )( $\text{mg}/\text{m}^3$ )	0.43	1.15	1.02	1.11	
	( $\text{g}/\text{m}^3$ )	<0.4	<0.4	0.6	<0.4	
	( $\text{g}/\text{m}^3$ )	0.4	<0.4	2.5	0.5	
	( $\text{g}/\text{m}^3$ )	<0.3	<0.3	1.8	<0.3	
	/ ( $\text{g}/\text{m}^3$ )	<0.6	<0.6	1.9	<0.6	
	( $\text{g}/\text{m}^3$ )	<0.6	<0.6	<0.6	<0.6	
	( $\text{g}/\text{m}^3$ )	<0.6	<0.6	0.9	<0.6	
	( $\text{g}/\text{m}^3$ )	ND	ND	2.8	ND	
	( $\text{mg}/\text{m}^3$ )	0.4	ND	7.7	0.5	
	( $\text{mg}/\text{m}^3$ )	<0.03	<0.03	<0.03	<0.03	
	( $\text{mg}/\text{m}^3$ )	<0.02	0.174	0.089	0.039	
	( $\text{mg}/\text{m}^3$ )	0.241	0.361	0.344	0.327	

---

(mg/m <sup>3</sup> )	0.013	0.023	0.018	0.017
(mg/m <sup>3</sup> )	0.07	0.12	0.13	0.14
(mg/m <sup>3</sup> )	<0.001	<0.001	<0.001	<0.001
( )	<10	11	11	11
ND				
VOCs(				
) (mg/m <sup>3</sup> )	0.36	1.15	1.04	1.17
( g/m <sup>3</sup> )	<0.4	<0.4	0.4	<0.4

2021.12.02

(GB16297-1996)

2 ( 1.0mg/m<sup>3</sup> 0.2mg/m<sup>3</sup> 0.12mg/m<sup>3</sup>)  
 (GB31573-2015) 5 VOCs  
 6 (DB37/2801.6-2018)

3 ( )  
 (DB37/3161-2018) 2 (2.0mg/m<sup>3</sup>)  
 6 (DB37/2801.6-2018) 3 ( )  
 0.2mg/m<sup>3</sup> 0.2mg/m<sup>3</sup> ( )  
 (DB37/3161-2018) 2 ( )  
 1.0mg/m<sup>3</sup> (GB14554-1993) 1  
 ( )  
 (DB37/3161-2018) 2 ( 1.0mg/m<sup>3</sup> 20)

			1#	2#
2021.12.01		(mg/m <sup>3</sup> )	1.22	1.34
		(mg/m <sup>3</sup> )	1.26	1.40
		(mg/m <sup>3</sup> )	1.33	1.31
2021.12.02		(mg/m <sup>3</sup> )	1.36	1.42
		(mg/m <sup>3</sup> )	1.32	1.37
		(mg/m <sup>3</sup> )	1.25	1.40

1# 2#  
 1.36mg/m<sup>3</sup> 1.42mg/m<sup>3</sup>  
 (GB37822-2019) A.1

(10mg/m<sup>3</sup>)

2

2021 11 24 2021

11 25

---

	pH	(mg/L)	(mg/L)	(mg/L)	( )	(mg/L)	(mg/L)	(mg/L)
	( )							
	12.6	610	192	67	200	21.8	124	28.7
	12.7	615	195	79	200	38	135	24.3
	12.8	620	164	82	200	35.8	103	26.8
	12.6	628	184	69	200	28.7	105	25.9
2021.11.24	7.6	76	7.7	19	5	6.46	14.4	1.12
	7.7	68	-7					

(GB/T31962-2015) 1 A									
( )		350		200	--				7.7
(GB31573-2015) 1	6 9		--		--	40	60		

ND

			(mg/L)	(mg/L)	(mg/L)	(mg/L)	( g/L)	( g/L)	( g/L)	( g/L)
2021.11.24			0.014	377	176	2.04 10 <sup>3</sup>	<0.3	ND	<0.2	ND
			0.017	335	173	2.16 10 <sup>3</sup>	<0.3	ND	<0.2	ND
			<0.01	262	173	2.18 10 <sup>3</sup>	<0.3	ND	<0.2	ND
			0.014	432	172	2.00 10 <sup>3</sup>	<0.3	ND	<0.2	ND
			<0.01	179	9.6	1.16 10 <sup>3</sup>	<0.3	ND	<0.2	ND
			<0.01	186	9.7	1.30 10 <sup>3</sup>	<0.3	ND	<0.2	ND
			<0.01	152	9.6	1.07 10 <sup>3</sup>	<0.3	ND	<0.2	ND
			<0.01	193	9.6	1.11 10 <sup>3</sup>	<0.3	ND	<0.2	ND
			<0.01	178	9.6	1160	<0.3	ND	<0.2	ND
2021.11.25			0.017	405	176	2.14 10 <sup>3</sup>	<0.3	ND	<0.2	ND
			<0.01	326	180	2.17 10 <sup>3</sup>	<0.3	ND	<0.2	ND
			0.014	274	168	2.26 10 <sup>3</sup>	<0.3	ND	<0.2	ND
			<0.01	441	174	2.23 10 <sup>3</sup>	<0.3	ND	<0.2	ND
		<0.01	167	9.6	1.05 10 <sup>3</sup>	<0.3	ND	<0.2	ND	

		<0.01	182	9.7	1.20 10 <sup>3</sup>	<0.3	ND	<0.2	ND
		<0.01	163	9.8	1.09 10 <sup>3</sup>	<0.3	ND	<0.2	ND
		<0.01	190	9.8	1.10 10 <sup>3</sup>	<0.3	ND	<0.2	ND
		<0.01	234	51.2	1160	<0.3	ND	<0.2	ND
		--	234	51.2	1160	--	--	--	--
(GB/T31962-2015)	1 A			--	--	--	--	--	
( )		--	--	--	--	--	--	--	--
(GB31573-2015)	1	--	--	--	--	--	--	--	--
3416.1-2018	1 DB 37	--	--	--		--	--	--	--

ND

---

---

pH

7.6 7.7

84 mg/L 8.1 mg/L 21 mg/L 5 7.62mg/L 19.2  
mg/L 1.12 mg/L 234 mg/L

(GB/T31962-2015) 1 A ( )

(GB31573-2015) 1

3

2021 11 23 2021 11 24

	2021.11.23		2021.11.24	
	Leq(dB(A))	Leq(dB(A))	Leq(dB(A))	Leq(dB(A))
	54	47	62	48
	56	47	63	53
	56	47	63	48
	55	46	61	49

54 63dB(A)

46 53 dB(A)

(GB12348-2008)3

4

9.2-8

						(5 )		
1				HW13265-103-13	4.2t/a	1.8 t	4.32t/a	
2				HW13265-101-13	2.25t/a	0.9 t	2.16t/a	
3				HW34261-057-34	10.57t/a	4.2 t	10.08t/a	
4				HW08 900-249-08	9t/8a	--	9t/8a	
5				HW49 900-039-49	11.4t/a	6 t	12t/a	
6				HW06 900-402-06	13t/a	5 t	12t/a	
7	( 30%)			HW13 265-104-13	235.88t/a	92.5 t	222 t/a	
8				HW49 900-041-49	1t/a	0.45 t	1.08t/a	
				--	99t/a	40 t	96t/a	
9				--	3.24t/a	1.3 t	3.12t/a	
10				HW11 900-013-11	11.8t/a	5 t	12t/a	

---

---

11					0.25t/3a	--	0.25t/3a	
12					1.314t/a	0.61t	1.464t/a	
13					27t/a	5.6t	13.44t/a	



		2022.03.21		2022.03.22		2022.03.21		2022.03.22	
pH		7.6	7.7	7.7	7.7	7.6	7.9	7.6	7.8
	mg/L	449	435	446	431	441	453	440	449
	mg/L	678	692	670	688	644	656	636	664
	mg/L	484	456	524	467	533	507	561	488
	mg/L	144	152	152	157	146	163	140	160
	mg/L	0.07	0.06	0.04	0.04	0.09	0.12	0.12	0.09
	mg/L	0.008L	0.008L	0.008L	0.008L	0.008L	0.008L	0.008L	0.008L
	mg/L	0.02	0.02	0.02	0.02	0.03	0.04	0.04	0.04
	mg/L	0.0003L	0.0003L	0.0003L	0.0003L	0.0003L	0.0003L	0.0003L	0.0003L
	mg/L	1.82	1.84	1.86	1.88	1.92	1.96	1.96	1.92
	mg/L	0.12	0.16	0.14	0.16	0.21	0.23	0.20	0.22
	mg/L	0.005L	0.005L	0.005L	0.005L	0.005L	0.005L	0.005L	0.005L
	mg/L	63.4	61.6	60.9	64.6	72.5	73.2	75.7	75.9
	MPN/100mL								
	CFU/mL	30	20	20	10		10	10	10
( N )	mg/L	0.001L	0.001L	0.001L	0.001L	0.001L	0.001L	0.001L	0.001L
( N )	mg/L	6.80	7.04	6.78	6.74	7.20	6.54	7.16	7.20
	mg/L	0.002L	0.002L	0.002L	0.002L	0.002L	0.002L	0.002L	0.002L

		2022.03.21		2022.03.22		2022.03.21		2022.03.22	
	mg/L	0.4	0.3	0.4	0.3	0.2	0.2	0.2	0.2
	g/L	0.07	0.06	0.06	0.07	0.13	0.07	0.08	0.07
	g/L	0.3L	0.3L	0.3L	0.3L	0.3L	0.3L	0.3L	0.3L
	g/L	0.5L	0.5L	0.5L	0.5L	0.5L	0.5L	0.5L	0.5L
	mg/L	0.004L	0.004L	0.004L	0.004L	0.004L	0.004L	0.004L	0.004L
	g/L	2.5L	2.5L	2.5L	2.5L	2.5L	2.5L	2.5L	2.5L
	g/L	1.4L	1.4L	1.4L	1.4L	1.4L	1.4L	1.4L	1.4L
	g/L	2.2L	2.2L	2.2L	2.2L	2.2L	2.2L	2.2L	2.2L
	g/L	1.4L	1.4L	1.4L	1.4L	1.4L	1.4L	1.4L	1.4L
	g/L	0.6L	0.6L	0.6L	0.6L	0.6L	0.6L	0.6L	0.6L
	mg/L	2.45	2.45	2.45	2.35	2.45	2.50	2.35	2.35
	mg/L	276	296	296	270	387	426	542	478
	mg/L	49.2	49.4	49.6	48.6	59.3	58.7	58.6	59.6
CO <sub>3</sub> <sup>2-</sup>	mmol/L	0	0	0	0	0	0	0	0
HCO <sub>3</sub> <sup>-</sup>	mmol/L	3.10	3.02	3.09	2.98	3.26	2.23	3.29	3.25
		+L							

( N

)

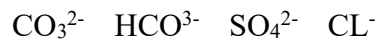

(

)

$$P = \frac{C}{C}$$

P<sub>i</sub> i

C<sub>i</sub> i mg/l

C<sub>oi</sub> i mg/l

--pH

$$P_{H_s} = \frac{7.0 - H}{7.0 - H_d} \quad H \leq 7.0$$

$$P_{H_s} = \frac{H - 7.0}{H - 7.0} \quad H > 7.0$$

P<sub>PHj</sub> pH

pH<sub>j</sub> pH

pH<sub>sd</sub> pH

pH<sub>su</sub> pH

1	pH	6.5 8.5	6		200mg/L
2		0.50mg/L	7		3.0mg/L
3	N	20.0mg/L	8		1.0 mg/L
4		450mg/L	9		250mg/L
5		1000mg/L	10		250mg/L

9.3-3

	2022.03.21		2022.03.22		2022.03.21		2022.03.22	
pH	0.40	0.47	0.47	0.47	0.40	0.60	0.40	0.53

---

	1.00	0.97	0.99	0.96	0.98	1.01	0.98	1.00
	0.68	0.69	0.67	0.69	0.64	0.66	0.64	0.66
	3.23	3.04	3.49	3.11	3.55	3.38	3.74	3.25
	0.58	0.61	0.61	0.63	0.58	0.65	0.56	0.64
	0.23	0.20	0.13	0.13	0.30	0.40	0.40	0.30
	0.02	0.02	0.02	0.02	0.03	0.04	0.04	0.04
	0.61	0.61	0.62	0.63	0.64	0.65	0.65	0.64
	0.24	0.32	0.28	0.32	0.42	0.46	0.40	0.44
	0.32	0.31	0.30	0.32	0.36	0.37	0.38	0.38
	0.30	0.20	0.20	0.10		0.10	0.10	0.10
( N )	0.34	0.35	0.34	0.34	0.36	0.33	0.36	0.36
	0.40	0.30	0.40	0.30	0.20	0.20	0.20	0.20
	0.07	0.06	0.06	0.07	0.13	0.07	0.08	0.07

10		mg/L	0.928	0.4	0.3	0.4	0.3
11	N	mg/L	0.018	0.001L	0.001L	0.001L	0.001L

2021 11 25

9.3-5

2021.11.25

(m)	0 0.5	0.5 1.5	1.5 3.0	0 0.5	0.5 1.5	1.5 3.0
(mg/kg)	9.76	11.0	9.01	9.84	10.2	10.0
(mg/kg)	0.046	0.049	0.047	0.044	0.051	0.038
(mg/kg)	0.08	0.12	0.11	0.07	0.17	0.10
(mg/kg)	<0.5	<0.5	<0.5	<0.5	<0.5	<0.5
(mg/kg)	19	16	24	17	28	30
(mg/kg)	24	35	31	35	32	33
(mg/kg)	54	29	29	22	45	36
( g/].g] :g						

2021.11.25						
(m)	0 0.5	0.5 1.5	1.5 3.0	0 0.5	0.5 1.5	1.5 3.0
( g/kg)	<1.3	<1.3	<1.3	<1.3	<1.3	<1.3
( g/kg)	<1.4	<1.4	<1.4	<1.4	<1.4	<1.4
1,1,1,2- ( g/kg)	<1.2	<1.2	<1.2	<1.2	<1.2	<1.2
( g/kg)	<1.2	<1.2	<1.2	<1.2	<1.2	<1.2
( g/kg)	<1.2	<1.2	<1.2	<1.2	<1.2	<1.2
/ ( g/kg)	<1.2	<1.2	<1.2	<1.2	<1.2	<1.2
( g/kg)	<1.1	<1.1	<1.1	<1.1	<1.1	<1.1
1,2,3- ( g/kg)	<1.2	<1.2	<1.2	<1.2	<1.2	<1.2
( g/kg)	<1.2	<1.2	<1.2	<1.2	<1.2	<1.2
1,1,2,2- ( g/kg)	<1.2	<1.2	<1.2	<1.2	<1.2	<1.2
1,4- ( g/kg)	<1.5	<1.5	<1.5	<1.5	<1.5	<1.5
1,2- ( g/kg)	<1.5	<1.5	<1.5	<1.5	<1.5	<1.5
( g/kg)	<0.4	<0.4	<0.4	<0.4	<0.4	<0.4
(mg/kg)	<0.09	<0.09	<0.09	<0.09	<0.09	<0.09
(mg/kg)	<0.09	<0.09	<0.09	<0.09	<0.09	<0.09
2- (mg/kg)	<0.06	<0.06	<0.06	<0.06	<0.06	<0.06
[a] (mg/kg)	<0.1	<0.1	<0.1	<0.1	<0.1	<0.1
[a] (mg/kg)	<0.1	<0.1	<0.1	<0.1	<0.1	<0.1
[b] (mg/kg)	<0.2	<0.2	<0.2	<0.2	<0.2	<0.2
[k] (mg/kg)	<0.1	<0.1	<0.1	<0.1	<0.1	<0.1
(mg/kg)	<0.1	<0.1	<0.1	<0.1	<0.1	<0.1
[a, h] (mg/kg)	<0.1	<0.1	<0.1	<0.1	<0.1	<0.1
[1,2,3-cd] (mg/kg)	<0.1	<0.1	<0.1	<0.1	<0.1	<0.1
(C <sub>10</sub> -C <sub>40</sub> )(mg/kg)	<6	<6	<6	<6	<6	<6
pH ( )	6.71	6.79	6.82	6.54	6.71	6.78
(mg/kg)	56.84	59.31	64.26	54.32	81.64	64.26

2021.11.25	
(m)	0 0.2

(mg/kg)	10.6
(mg/kg)	0.055
(mg/kg)	0.21
(mg/kg)	100
(mg/kg)	92
(mg/kg)	22
(mg/kg)	35
(mg/kg)	47
(C <sub>10</sub> -C <sub>40</sub> )(mg/kg)	<6
pH ( )	6.59
(mg/kg)	74.14

	2021.12.23
(m)	0 0.2
( g/kg)	<1.9
( g/kg)	ND
( g/kg)	<1.1
	ND

( ) (GB 36600-2018) ( ) ( ) (GB 15618 2018)

1,1- 1,2- 1,1- 1,2- 1,1,1- 1,2- 1,1,2- 1,1,1,2- / 1,2,3- 1,1,2,2- 1,4- 1,2- (mg/kg) 2- [a] [a] [b] [k] [a, h] [1,2,3-cd] (C<sub>10</sub>-C<sub>40</sub>) ( ) 40

6

8

	( ) (GB 36600-2018)	( ) (GB 15618 2018) (6.5 pH 7.5)
1	60	30
2	38	2.4
3	65	0.3
4	900	100
5	18000	100
6	800	120
7		250
8		200

$$S = \frac{C}{C}$$

S<sub>i</sub>C<sub>i</sub> i mg/kgC<sub>si</sub> i mg/kg

	0.0-0.5m	0.5-1.5m	1.5-3.0m	0.0-0.5m	0.5-1.5m	1.5-3.0m	0.0-0.2m
	0.16	0.18	0.15	0.16	0.17	0.17	0.35
	0.0012	0.0013	0.0012	0.0012	0.0013	0.0010	0.02
	0.0012	0.0018	0.0017	0.0011	0.0026	0.0015	0.70
	0.021	0.018	0.027	0.019	0.031	0.033	0.22
	0.0013	0.0019	0.0017	0.0019	0.0018	0.0018	0.47
	0.068	0.036	0.036	0.028	0.056	0.045	0.39
	--	--	--	--	--	--	0.50
	--	--	--	--	--	--	0.37

( ) (GB36600-2018)

( ) (GB15618-2018)

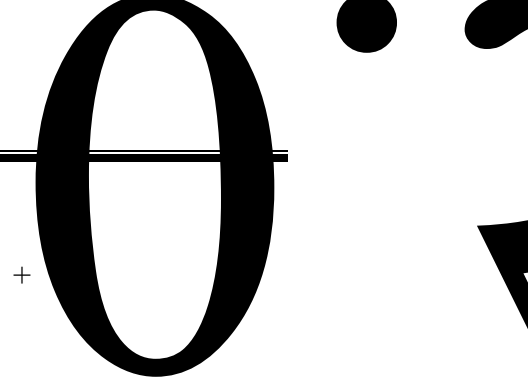

			0.0-0.5m	0.0-0.5m
1	(mg/kg)	5.81	9.76	9.84
2	(mg/kg)	0.038	0.046	0.044
3	(mg/kg)	0.12	0.08	0.07
4	(mg/kg)			

(ଅନ୍ଧା)

---

1		
2		
3  ) ( 5	2019 10 28 [2019]210	

00



( )

2019 6

2019 10

28

[2019]210

2019 11

2021 3

2021 4

2021 8

35000

2010.68

74667m

1#

2#

.6

5500 / □ PVAC

3000 /

1045 /

3030 /

1500

/

0000 /

2500 /

\*

7 YAM 8





				6		(DB37/2801.6-2018)
1	2					GB 37824-2019
1					(GB 31572-2015)	4 VOCs(
	)			6		
(DB37/2801.6-2018)	1					(GB14554-93)
2						
						1.16mg/m <sup>3</sup>
0.019mg/m <sup>3</sup>	5.8mg/m <sup>3</sup>					
0.004kg/h	0.021kg/h	0.02kg/h	0.017kg/h			
				(DB37/2376-2019)	1	
						(GB31573-2015) 3
(GB16297-1996)	2					
					VOCs(	)
					3.42mg/m <sup>3</sup>	0.14mg/m <sup>3</sup>
0.012mg/m <sup>3</sup>	0.65mg/m <sup>3</sup>	550(	)	VOCs(	)	
		0.019kg/h	7.76 10 <sup>-4</sup> kg/h	6.27 10 <sup>-5</sup> kg/h	3.59 10 <sup>-3</sup> kg/h	
VOCs(	)					
				(	)	
(DB37/3161-2018)	1					
2.4mg/m <sup>3</sup>	4.0mg/m <sup>3</sup>	36mg/m <sup>3</sup>				
	8.63 10 <sup>-3</sup> kg/h	0.0144kg/h	0.137kg/h	<1		SO <sub>2</sub>
NO						(DB37/2374-2018)
2						
2#					3.8mg/m <sup>3</sup>	
	0.021kg/h					(DB37/2376-2019)
1					(GB 31572-2015)	4
					GB 37824-2019	1
				(GB16297-1996)	2	

(2)

VOCs( ) 1.29mg/m<sup>3</sup>

0.6mg/m<sup>3</sup> 2.5mg/m<sup>3</sup> 0.5 g/m<sup>3</sup>

2.8 g/m<sup>3</sup> 7.7mg/m<sup>3</sup> 0.174mg/m<sup>3</sup>

0.395mg/m<sup>3</sup> 0.025mg/m<sup>3</sup>

0.14mg/m<sup>3</sup> 14( )

(GB16297-1996)

2 ( 1.0mg/m<sup>3</sup> 0.2mg/m<sup>3</sup> 0.12mg/m<sup>3</sup>) VOCs

6 (DB37/2801.6-2018)

3 ( )

(DB37/3161-2018) 2 (2.0mg/m<sup>3</sup>)

6 (DB37/2801.6-2018) 3 (

0.2mg/m<sup>3</sup> 0.2mg/m<sup>3</sup>) ( )

(DB37/3161-2018) 2 (

1.0mg/m<sup>3</sup>) (GB14554-1993) 1

( )

(DB37/3161-2018) 2 ( 1.0mg/m<sup>3</sup> 20)

3

54 63dB(A)

46 53 dB(A)

(GB12348-2008)3

4

---

11.3.1

(GB/T14848-2017)

1.01

3.74

(GB/T14848-2017)

11.3.2

( ) (GB36600-2018)

( ) (GB15618-2018)

11.4.1

1#

2#

100m

560m

11.4.2

---

( 370911-2022-003-M)

11.4.3

0.92t/a	2.63t/a	0.386t/a	1.536t/a
			0.023t/a
0.674t/a	0.184t/a	0.735t/a	

1

2

3

4

5